



instruction book
VOLVO 164



VOLVO 164

Operating Instructions

Description

Servicing

AKTIEBOLAGET VOLVO GÖTEBORG SWEDEN

Reprinting permitted if source quoted

FOREWORD



Before you start driving your new Volvo please read through this instruction book carefully. It contains all the information you need to be able to drive and service your vehicle in the best possible way. By following the instructions given in this book, you will find that your Volvo will come up to all the expectations concern-

ing economical operation and excellent performance that you have every right to expect of a top-quality vehicle.

This instruction book is not intended to be a comprehensive technical manual and does not claim to make the reader a perfect car mechanic. It will, however, show you how to look after your vehicle

so that trouble in the future can be avoided. The better you know your Volvo, the better service it can give you. Even for an experienced motorist this book can contain some valuable information. For a more detailed mechanical description as well as repair procedures, we refer you to the special Service Manual for the car.

INTRODUCTION

Volvo Service Organization 4
 Warranty and Service Booklet 4
 Service Inspections 4
 Type Designations 5

OPERATING INSTRUCTIONS

Instruments and controls 6
 Interior and body 14
 Starting and driving 19
 Running-in 19
 Starting the engine 20
 Gear-changing 21
 Towing 23
 Braking 23

TECHNICAL DESCRIPTION

Engine compartment 24
 Engine 25
 Power transmission 26
 Front end and steering 29
 Electrical system 30
 Brakes 32

SERVICING

General 33
 Maintenance scheme 34
 Lubrication 36
 Oil changes 37
 Engine 41
 Electrical system 44
 Power transmission 49
 Brakes 49
 Front end 49
 Wheels and tyres 50
 Body 52
 Long-distance trip 54
 Cold weather 54
 Lubricating chart 60

FAULT TRACING

When the engine stalls 56

SPECIFICATIONS

Measurements and weights 57
 Engine 57
 Electrical system 58
 Power transmission 59
 Front wheel alignment 59
 Wheels and tyres 59
 Capacities 59

INTRODUCTION

Volvo Service Organization

To get the most out of the invested capital represented by a car, it must be looked after and serviced regularly. Volvo has gone to a great deal of trouble in the design and selection of material to ensure that the car in question only requires a minimum of servicing. We rely, however, on your co-operation with regard to the future maintenance of your vehicle. To help you with this, Volvo has built up a world-wide service organization. All Volvo dealers have specially trained personnel and receive a continuous supply of technical information from the Volvo Service Organization concerning repairs and adjustments. They also have special tools, designed at the Volvo factory. Moreover, all Volvo dealers have a comprehensive stock of spare parts which is your guarantee for genuine Volvo spares. That is why our dealers are in the best possible position to give your vehicle first-class ser-

vice concerning both maintenance operations and repairs. You should also refer to your dealer for any information about your Volvo that is not included in this instruction book.

Not only has Volvo a workshop within call in your own country, it has also a widely distributed service network in other countries.

Warranty and Service Booklet

A warranty and service booklet accompanies each vehicle when it is delivered. This booklet contains a coupon entitling you to a service inspection after 2,500 km (1,500 miles). If possible, let the dealer who supplied the vehicle carry out this service inspection. Any of our dealers, however, can do this if required.

If our six-month guarantee is to apply, we make one absolute condition and that is that the above-mentioned inspection is carried out at roughly the mileage shown and that the vehicle has been looked after in accordance with the instructions given in this book.

Service Inspections

After the 2,500 km (1,250 miles) service inspection has been carried out, you should come to some arrangement with your dealer concerning continued, regular service inspections in accordance with the suggestions made in our Service Book. Thorough and regular servicing is of vital importance for the performance and length of life of the vehicle. Always use genuine Volvo spares.



Type designations

In all correspondence concerning your vehicle with the dealer and when ordering spare parts, the type designation, chassis and engine number should always be quoted.

1. Vehicle type designation, code numbers for colour and upholstery; on bulk-head.
2. Body number.
3. The designation for type and model together with chassis number are punched into the front right-hand door post.
Above the chassis number on the door post there is also the code for dip and primer paints.
Type designation and chassis number plate located also on inside of left-hand windscreen post.
4. Type designation, serial number and parts number of engine; stamped on engine left-hand side.
5. Type designation, serial number and part number of gearbox; underneath gearbox.
6. Number of final drive gear teeth and reduction ratios; on a plate on the lower part of the inspection cover.

OPERATING INSTRUCTIONS

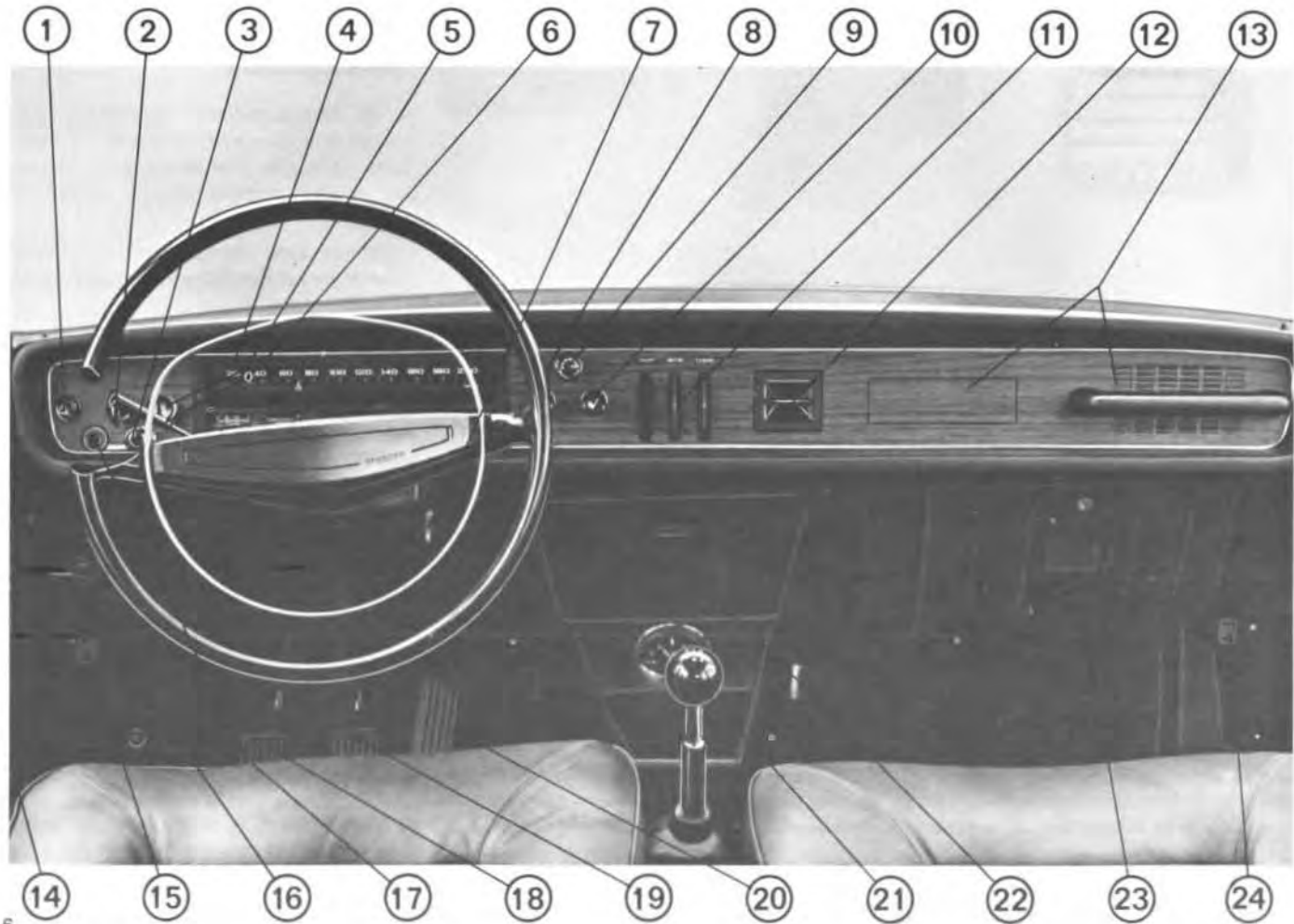

INSTRUMENTS AND CONTROLS

1. Windscreen wiper and washer switch
2. Choke control
3. Switch for elec. heated rear window
4. Instrument panel
5. Lighting switch
6. Turn indicator switch, dimmer and headlight flasher
7. Combined ignition switch and steering wheel lock
8. Fan switch
9. Emergency warning flasher switch
10. Cigarette lighter
11. Heater/ventilation controls
12. Ashtray
13. Place for radio and loudspeaker
14. Parking brake
15. Fresh-air intake, left
16. Bonnet release
17. Foglight switch
18. Clutch pedal
19. Brake pedal
20. Accelerator pedal
21. Clock
22. Fuses
23. Glove locker
24. Fresh-air intake, right

The instruments and controls are described in more detail in the following pages with a reference to the numbers in the picture opposite. Note that variations may occur between different markets.



- 1 Windscreen wiper and washer switch

The windscreen wipers are operated electrically and can be adjusted to two speeds. Normal speed is attained by pulling the switch out to the first position. This speed is recommended for driving normally in rainy weather or snow.

When the switch is pulled out fully, the wipers operate at full speed. Full speed is only recommended when driving in heavy rain or when driving at high speed when it is raining.

When the switch is pressed in fully, the wiper blades stop in their parking position. The windscreen washer are operated by turning the switch clockwise. When released, the switch automatically returns to its starting position and shuts off the washers. The washers can be used without the windscreen wipers. The fluid container for the washers is located in the engine compartment and holds about 1/2 litres (2³/₄ Imp. pints = 3/4 US pints).

- 2 Choke control



The choke control is used when the engine is started from cold. When the control is pulled out about 10-15 mm (1/2"), the idling speed is increased. Pulling the control out further, enriches the fuel-air mixture. This steps up the idling speed.

- 3 Switch, electrically heated rear window



In order to obtain a clear view through the rear window during cold and damp weather, your Volvo is fitted with an electrically heated rear window.

Heating is by means of wires on the inside of the rear window. For this reason, avoid placing anything on the rear shelf which could damage the wires.

The switch has two positions. Pulled out to the first stop, there is an output of approximately 50 W, and when pulled out to second stop, the output will be about 200 W. As long as the electric heating is on, a warning lamp lights in the switch.

As soon as the rear window is free from moist and ice, push in the switch, either one stop or fully, in order not to overload the battery unduly.

OPERATING INSTRUCTIONS

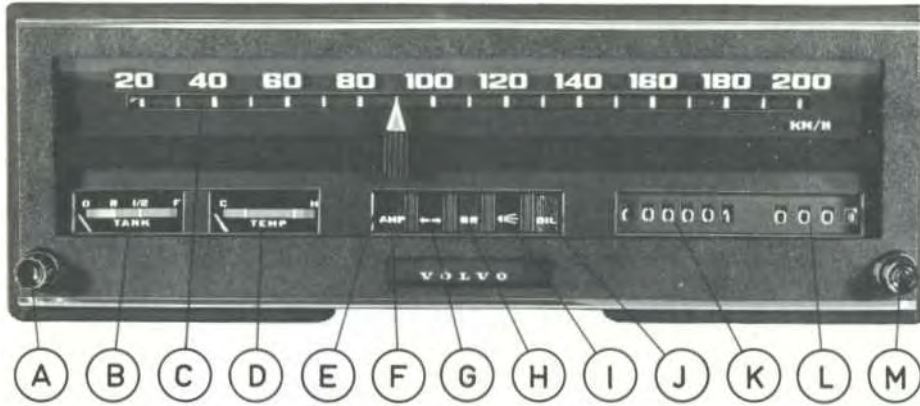

C Speedometer

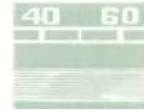

The speedometer consists of a horizontal scale marked in intervals of 10 m.p.h. The speed is indicated by a red ribbon.

D Coolant temperature gauge



The temperature gauge shows the temperature of the coolant and thus indicates the working temperature of the engine. The pointer on this should normally remain within the green sector.

It is permitted for the temperature gauge pointer to enter the red-lined field during town driving and idling when the weather is particularly hot.

E Speed warning indicator



The speed warning indicator is mounted in front of the speedometer and consists of a manually adjustable sliding arrow. Its purpose is to remind the driver of the particular maximum permissible speed in connection with speed limit regulations.

4 Instrument panel

A Panel light switch

B Fuel gauge

C Speedometer

D Coolant temperature gauge

E Speed warning indicator

F Warning light, charging

G Turn indicator warning light

H Parking brake warning light (functions also as warning light for both service brake circuits)

I Mainbeam warning light

J Oil pressure warning light

K Mileometer

L Trip meter

M Trip meter reset knob

A Panel light switch



Turning the knob clockwise or anticlockwise increases or dims the lighting on the instrument panel.

B Fuel gauge



The fuel gauge indicates approximately the amount of fuel in the tank. The gauge is graduated "full", "half", "reserve" and "empty". The red field between "reserve" and "empty" is a remainder that the tank should be filled. When the gauge pointer is on "reserve" there are approx. 8 litres (2 Imp. galls = 2½ US galls) in the tank.

F Warning light, charging



This lights red when the battery is discharging, which is normal at idling speed. As soon as you accelerate a little, it should go out. Should it light up during driving, either there is some fault in the electrical system or the fan belt is not sufficiently tensioned and is thus slipping on the alternator pulley, causing poor charging.

on during driving, the car should be driven without delay to a workshop for a check on the brake system. Observe due care when driving under such conditions.

G Turn indicator warning light



This lamp flashes with a green light when the turn indicator switch is moved upwards or downwards and the ignition is on.

I Mainbeam warning light



This lights blue when the headlights are switched to mainbeam by the switch lever (6).

H Parking brake warning light
(functions also as warning light for both service brake circuits)



This lights red when the parking brake is applied and the ignition is on. The light also functions as a footbrake circuit warning light should a failure arise in one of the brake circuit. If the light goes

J Oil pressure warning light



This lights yellow when the engine oil pressure is too low. When the ignition is switched on, the light should go on and then go out again when the engine starts. Never start driving until the light goes out. If the light goes on during driving, stop the engine and find out the reason for this. In most cases it means that the oil level is too low. After hard driving it may happen that the warning light comes on when the engine is idling. This is normal providing it goes out again when engine speed is increased.

K Mileometer



The mileometer shows the total distance covered in miles. After 999999 miles it returns to zero and starts to go round again.

L Trip meter



The trip meter measures distances of up to maximum 999 miles. The window further to the right is graduated in tenths of a mile and can thus be used to measure short distances.

M Trip meter reset knob



The trip meter is set to zero by pushing in the reset knob.

OPERATING INSTRUCTIONS

5 Lighting switch



The headlights are operated by means of a push-pull type switch on the dashboard as well as a lever (6) on the steering column.

All the lights are extinguished when the lighting switch is pushed fully in. Pulling it out to the half-way position, switches on the parking lights and when it is fully out, the full or dipped headlights are switched on, depending on the position of the lever (6).

Since the lighting system is not connected across the ignition switch, the lights will function irrespective of whether the ignition key is in position or not.

On certain markets the Volvo 164 is fitted with side marker lights. These are located on the sides of the mudguards and are switched on by pulling out the switch for the parking lights and headlights.

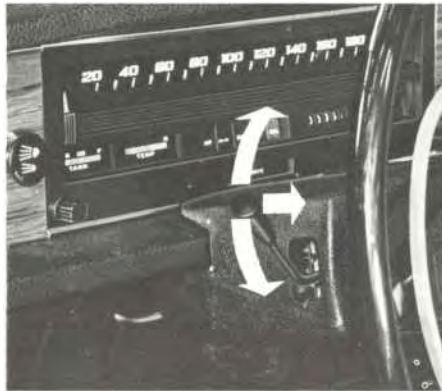

Switching from mainbeam to dipped and vice versa is carried out by moving the lever towards the steering wheel and then releasing it. Here the lighting switch (5) should be pulled out fully.

The lever is also used for flashing with mainbeam when the headlights are not switched on. The headlight flasher is switched on by moving the lever towards the steering wheel and it remains switched on until the lever is released.

6 Turn indicator switch, dimmer and headlights flasher

The switch lever on the left-hand side of the steering column behind the steering wheel controls the turn indicators, dipped headlights and headlight flasher.

Moving the lever upwards, operates the right-indicator, and downwards the left-indicator.



7 Combined ignition switch and steering wheel lock

The switch has four positions: (0) Locking position, (1) Intermediate position, (2) Driving position and (3) Starting position. The key can only be inserted or taken out of the lock in the Locking position. Removing the key automatically locks the steering wheel.

On certain markets the ignition switch is provided with a buzzer which warns the driver on opening the driver's door that the

key has been forgotten in the ignition switch.

Except for the engine ignition system, the electrical system is switched on with the key in the Intermediate position.

To start the engine, turn the key to the Starting position and this automatically engages the starter motor. As soon as the engine starts, release the key which automatically returns to the Driving position.

If the car is parked in such a way that it is difficult to unlock the steering wheel, turn the wheel slightly one way then the other.

9 Switch emergency warning flashers



All the four warning lights start flashing simultaneously when the switch is pulled out. A control lamp mounted in the switch blinks in unison. The warning lights are not connected across the ignition and therefore function irrespective of whether the ignition key is inserted or not.

These warning lights should be used only when you have to stop the car where there is possible danger to other traffic. Note that regulations governing the use of these lights may vary on different markets.

8 Fan switch



The fan is operated by means of a push-pull switch which can be set at two different positions. Pushing the switch fully in stops the fan, pulling it out to the first position operates the fan at full speed and when pulled out fully, the fan operates at half speed.

Due to the aerodynamic design of the car, the overpressure in the air intake is relatively small. Therefore, at speeds below 80 km.p.h. (50 m.p.h.), the fan should be allowed to operate at full speed if maximum air capacity is desired. On the other hand, however, the fan should not be used if cooling air is required on a hot summer's day. Instead, open both the fresh-air controls (15, 24), the defroster control "DEFR" and the ventilation control "FLOOR".

10 Cigarette lighter



To use the cigarette lighter, push it in. The lighter releases automatically when it attains sufficient heat.

11 Heater/ventilation controls



The control on the left, TEMP, regulates the temperature of the incoming air. The middle control, DEFR, regulates the air flow to the windscreen. And the control to the right, FLOOR, regulates the air flow to the front seat and rear seat floor. The temperature, also the air flow, is increased by moving the controls downwards whereby a red strip marked down the middle of the control in question indicates the size of the opening. Note that when altering the temperature control, there will be a slight delay before the desired temperature is reached.

To avoid mist on the windows, set the fan and defroster controls at maximum output and close the FLOOR control. The fresh-air controls (15, 24) should be closed. Try to avoid water on the floor and under the mats as this increases humidity and thereby misting, particularly during the wintertime.

OPERATING INSTRUCTIONS

14 Parking brake



The parking brake lever is on the outside of the driving seat and operates on the rear wheels only. When the parking brake is applied and the ignition is on, a red warning light (4, H) shows on the instrument panel.

Remember that the footbrake warning system is also connected to this light. Should the light show when the parking brake is not on, this may be due to a failure in one of the brake circuits. If this is the case, drive immediately (but with due care) to a workshop for a check.



16 Bonnet release handle

The bonnet lock is released by pulling out the handle situated to the left of the steering column lower down on the dashboard.

This releases the bonnet which is still retained by the safety catch.

The bonnet is opened by inserting the fingers under its front edge and pressing in the catch as shown in the picture right above. Raising the bonnet causes a light in the engine compartment to go on automatically. Make sure that the bonnet is locked properly when closed.

The level of the bonnet can be adjusted if necessary by screwing out or in the rubber plugs under the bonnet at the front and on the mudguards.

15, 24 Fresh-air controls

Sliding the control forwards opens a fresh-air intake on the driver's or passenger's side. Note that the fan should not be operating if cool air is desired through these intakes.

17 Foglight switch

On certain markets the Volvo 164 is fitted with 2 extra foglights. These are switched on by pulling out the foglight switch, providing that either the parking or dipped-beam lights are on.



Because of regulations on certain markets, the foglights are connected across the parking and headlights or only the parking lights.



Clock

For certain markets, the Volvo 164 is fitted with an electric clock. The clock is set by pushing in the knob in the middle of the clock and turning the hands to the desired time. Vehicles not fitted with a clock have an odometer console fitted instead in front of the gear lever.

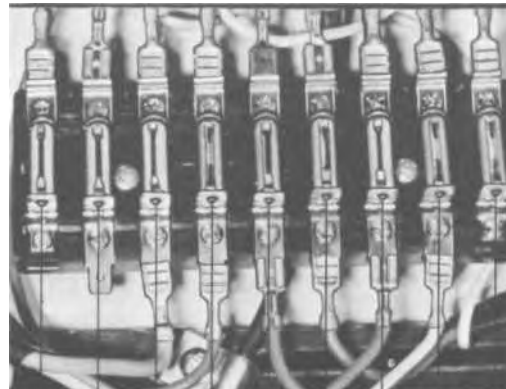

22 Fuses

The electrical equipment is protected by a number of fuses housed in a compartment under the dashboard. If a fuse has to be replaced, always make sure that it is replaced with a fuse of the correct rating. If fuses burn out repeatedly, do not replace with a fuse of higher rating but have a workshop check the electrical system.

On the inside of the cover of the fuse compartment there is room for a number of spare fuses.

The two fuses for the foglights are located in a fusebox on the left-hand side in the engine compartment.

- 1. Windscreen wipers, washer 8A
- 2. Horn, reversing lights 8A



- 3. Heater fan, control relay for elec. heated rear window 8A
- 4. Warning lamps
Instrument panel
Flasher 5A
- 5. Elec. heated rear window, overdrive 16A
- 6. Interior lighting
Glove locker
Dimmer relay 5A
- Engine compartment lighting
Luggage compartment lighting
Acoustical warning buzzer
- 7. Brake lights
Emergency warning flashers 8A
- Clock
- 8. Left rear light
parking light
side marker light 5A
- Instrument panel light
Number panel light
- 9. Right rear light
parking light
side marker light 5A
- Clock light
- 10. Right foglight 8A
- 11. Left foglight 8A

OPERATING INSTRUCTIONS

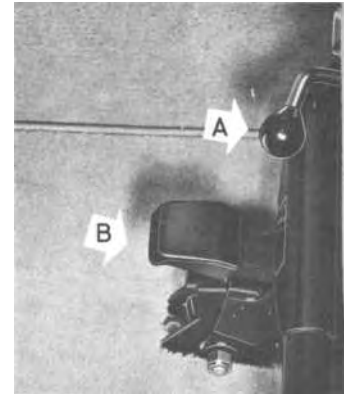
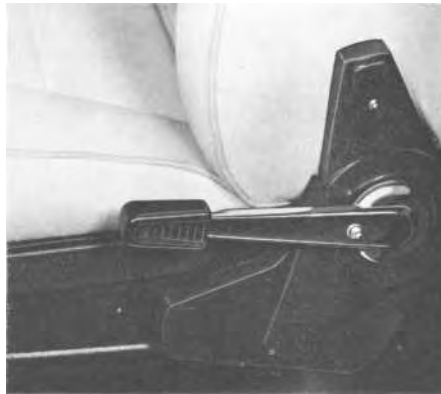

INTERIOR AND BODY

Front seats

Lumbar support

The front seats are provided with an adjustable lumbar support. This is operated by means of the knob on the inside of the backrest. To tension the lumbar support, and thus exert more pressure against the small of the back, turn the knob clockwise, "FIRM", and to relieve the pressure against the small of the back, turn the knob anti-clockwise, "SOFT".

Bench-type front seats have the knob mounted on each side of the seat.

Backrest adjustment

The front seat backrest is adjusted with the lever on the outside of the backrest (see picture). Lift up the lever, adjust to the desired angle, and lock the backrest there by pushing down the lever. The backrest can be folded backwards to a comfortable rest or repose angle.

Length and height adjustment driver's seat

The driver's seat can be adjusted forwards-backwards by lifting catch A upwards. Exert leverage with your feet on the floor and slide the seat to the most comfortable position. On bench-type front seats, the catch is located at the driver's seat.

Adjustment is made vertically by lifting catch B upwards and then setting the seat to one of the four height positions. If necessary, the seat can then be adjusted longitudinally.

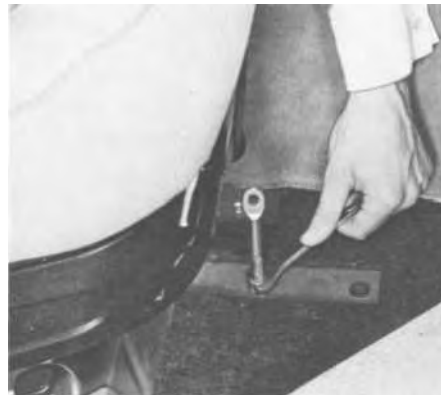

Length and height adjustment front passenger's seat

The front passenger's seat can be adjusted forwards-backwards by pressing down catch C on the outside of the seat. Vertically the seat is adjustable to three different positions. Remove the seat cushion to get to the bolts in the seating bracket. Remove the two bolts holding the seating frame to the seating brackets. Place the frame in the desired position and refit the bolts in the suitable holes.

In connection with this adjustment, it may be desirable or necessary to adjust the inclination angle of the entire seat. This is done with the eyelet bolt at the front under the seat frame. Remove the bolt which goes through the eyelet screw and

fold the seat backwards. Then release the locknut in the floor of the car and adjust the eyelet screw to the desired position. Re-lock securely the eyelet screw with the locknut.

The passenger's seat can be used facing opposite the driving direction in order to hold a safety seat for a child. This is done by removing the four bolts holding the seat frame to the sliding rails. Lift off the seat, turn it back to front on the slide rails and retighten the nuts. Note that the lock fittings should remain on the right-hand side in order to be able to lock the seat.

Head restraints

The front seats are provided with adjustable head restraints. If the head restraint is to fulfil its function properly, it is important that it is correctly adjusted, that is, it supports against the head and not only against the neck. The car is delivered with the head restraints adjusted to standard height. To adjust slacken the plastic nuts on the head restraints retainers. After adjusting lock the head restraints by turning the plastic nuts clockwise.

OPERATING INSTRUCTIONS



Safety belts

Always use the safety belt for all types of driving. Remember that it is possible even in slow city traffic to incur serious injury from sudden, unexpected stopping.

Automatically retracting inertia safety belts

The Volvo 164 is equipped with automatically retracting inertia safety belts.

To fit the belt, pull out the webbing slowly. If the webbing is pulled out too quickly, the emergency-locking retractor reacts and locks the belt. Normally the safety belt retractor is "unlocked". Locking takes place when the webbing is pulled

out rapidly or when the car is braked suddenly.

Should the webbing lock when being pulled out, slacken off slightly and then continue pulling out more slowly. Place one strap round the waist and the other across the shoulder - chest and secure the belt by pushing the buckle tongue into the locking slot in the lock between the seats. An audible clicking sound is a sign that the belt is locked.

Make sure that the webbing fits comfortably across the body and is not twisted.

The belt is released by pulling up the lever in the locking device. Make a habit of letting the roller roll up the webbing on removing the belt.

Safety belts in rear seat

For certain markets, safety belts for three passengers are installed in the rear seat. The belts are fastened by pushing the buckle tongue on the strap into the lock in the other. The belts are released by lifting the "cap" and separating the straps.

To shorten the belt, pull in the upper section of the lap belt. To extend it, pull in the lower section.

When not being used, the side belts should be attached to the hooks on the rear window. There is a similar attaching device behind the armrest for the centre belt.

OPERATING INSTRUCTIONS



Do not let the belt lie on the floor otherwise it will get entangled and dirty as well as hinder getting in and out of the vehicle.

Now and again check that the bolts anchoring the belts are properly tightened and that the belt is otherwise in good condition. Water mixed with some synthetic washing agent can be used for cleaning the belt. If the belt is exposed to violent stretching, for example, in connection with a collision, it should be replaced even though it may appear to be undamaged. Also replace the belt if well worn or damaged.

Never modify or repair the belt on your own, but have this done by a Volvo workshop.



Doors and locks

The car is fitted with a lock and keyhole on each of the front doors.

All the doors can be locked on the inside by pressing down the lock plunger on the window ledge. On the front doors this lock plunger lifts automatically when the door is opened from the inside. On the rear doors, however, the lock plunger must first be pulled up before the doors can be opened from the inside. This is an advantage if children are in the back seat.

The front doors can be locked from the outside by pressing the lock plunger on the window ledge down and shutting the door while pushing in the outside door handle button. To lock the rear doors it is not necessary to push in the buttons.

Do not leave the keys in the car.

The door locks have been designed with a view to providing maximum possible protection against freezing during the wintertime. As an extra measure, however, you should lubricate the locks regularly during very cold weather with a suitable anti-freeze agent. If the lock is already frozen, be careful not to break the key in the lock. Instead, heat the key and immediately place it in the lock. This should unfreeze the lock. Should you lose the car keys, contact your nearest Volvo dealer for new ones and quote the code number of the keys which have been lost.

Ventilation window lock

To open the ventilation window first slacken the small lock screw a couple of turns, push it in and then turn the handle forwards. On certain markets the window is opened merely by pressing in the button and turning the handle.

Rearview mirror

The inside rearview mirror can be switched to anti-dazzle by pushing the knob at the bottom sideways.

If it is to fulfil its function well, the outer rearview mirror on the passenger side should be turned so that the arm is vertical.

OPERATING INSTRUCTIONS



Interior lighting

1. The light comes on when either front door is opened.
2. The light is always extinguished.
3. The light is always on.



Sun-roof

On certain cars, the Volvo 164 is available with a sun-roof. The sun-roof is opened and closed by a winding handle. When not in use, the handle is folded in the recess in the roof between both the sun visors. To close the sun-roof, wind it forwards fully, then wind back the handle a little and fold it into the recess in the roof.



Luggage compartment

The luggage compartment lid is locked with the same key as that used for the doors. The lid is opened by turning its handle clockwise and lifting it at the same time. Note that the key must be removed from the lock in order to turn the lock knob. The lid is balanced and will remain stationary in its opened position.

The luggage compartment light goes on automatically when the lid is opened. The spare wheel is securely held in position to the right. The jack and tool kit are fastened to the spare wheel. Under the luggage compartment floor to the left there is space sufficient for an extra spare wheel, for stowing tools or a reserve fuel can.



STARTING AND DRIVING

Running-in instructions

When the vehicle is new, we recommend that a certain amount of caution be observed during the running-in period, for it is during this time that the movable parts of the car must be properly bedded in so as to obtain smooth and durable sliding surfaces. The maximum permissible speeds, therefore, should not be exceeded.

	during the first 1000 km (600 miles)	between 1000 and 2000 km (600 and 1200 miles)
1st speed	30 km.p.h. (20 m.p.h.)	50 km.p.h. (30 m.p.h.)
2nd speed	55 km.p.h. (35 m.p.h.)	75 km.p.h. (47 m.p.h.)
3rd speed	80 km.p.h. (50 m.p.h.)	100 km.p.h. (60 m.p.h.)
4th speed	110 km.p.h. (70 m.p.h.)	130 km.p.h. (80 m.p.h.)

Avoid driving at low speed in high gear and using the kick-down (automatic transmission) during the first 2000 km (1200 miles).

Warranty Inspection

After 2500 km (1500 miles), the vehicle should be taken to a Volvo workshop for the warranty inspection. The procedure then carried out includes changing the oil in the engine, gearbox and rear axle. It is very important to ensure that this oil change is carried out since during this running-in period the engine oil usually collects a lot of impurities. After this oil change, future changes should be carried out at approximately those intervals indicated in the maintenance scheme on page 34 and in the lubricating chart at the end of the book. All Volvo engines are test-run before being delivered. We are therefore

OPERATING INSTRUCTIONS

assured that all clearances are satisfactory and we thus accept no responsibility for damage caused by careless running-in.

Before your first drive

Before you begin driving your new Volvo, we would advise you to become familiar with the vehicle and the various instruments and controls used during driving. Sit in the car, go through all the various instruments, test the controls and adjust the seats and rearview mirror to the position which suits you best. When you are comfortably seated and acquainted with the location of the various controls, you are ready to begin driving.

Start the engine

as follows:

1. Check that the parking brake is on and the gear lever is in neutral (position "N" or "P", automatic transmission).
2. When the engine is cold, pull the choke control out fully.
3. Always make a habit of depressing the clutch pedal until the engine fires normally.
4. Turn the ignition key to the starting po-

sition. Release the key as soon as the engine has started.

5. Push in the choke until the best idling speed is obtained. As the engine becomes warmer, push in the choke more and more. Drive for as short a period as possible with the choke out. Thanks to the air preheating device, the engine should be running smoothly soon after starting. When the engine is thoroughly warm, the choke should be pushed right in. After starting a cold engine, do not race it immediately but run it at moderate speed and do not subject it to heavy loading until the engine temperature has reached normal level.

When starting with a warm engine, depress the accelerator pedal lightly. If warm engine does not start immediately, depress the accelerator pedal fully and keep it depressed until the engine starts.

Starting in a garage

Before starting your car in a garage, always open the garage doors. The exhaust gases from the engine contain carbon monoxide gas which is poisonous and particularly dangerous since it is invisible and odourless.

Warming up the engine

Experience has shown that engines in vehicles used with frequent stopping and starting are subject to abnormally rapid wear. The reason for this is that the engine is not given a chance to reach its normal working temperature. When the engine is cold, it should just be taken up to its normal working temperature as quickly as possible. Therefore, do not idle the engine too long but start driving with a light load on the engine as soon as the oil pressure light has gone out.

Driving with the luggage compartment lid open

While driving with the luggage compartment lid partly or fully open, exhaust gases can be sucked into the car through the boot. Normally, this involves no risk to the passengers. However, the following advice should be followed on such occasions.

1. Keep all windows closed.
2. Set the fresh air and defroster controls to the fully-opened position and the fan control to full speed.



GEAR-CHANGING

The Volvo 164 is fitted with a gearbox with or without overdrive or an automatic transmission.

Note that not all these types of transmissions are available on a number of markets.

Floor-mounted gear lever

Gear-changing with the floor-mounted gear lever is quite conventional and the different gear positions are shown in the picture above.



Overdrive

The overdrive is engaged by means of the lever under the steering wheel on the right-hand side of the steering column. When the overdrive is engaged, a red light shows on the dashboard. Any extra manoeuvring with the clutch pedal is normally not required.

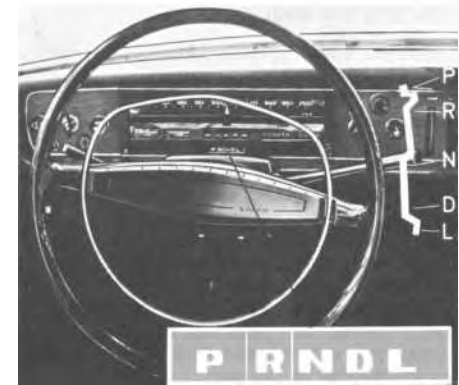

Automatic Transmission

At the bottom of the instrument panel in the middle there is a quadrant for indicating the selector lever position. The selector lever has the following positions:

- P = Parking
- R = Reverse
- N = Neutral
- D = Driving
- L = Low gear

Recommended speed ranges, km.p.h. (m.p.h.) for the different gears¹⁾

1st gear	2nd gear	3rd gear	4th gear
0–55 (0–35)	25–85 (15–50)	35–125 (20–72)	45– (25–) ²⁾

¹⁾ Applies after 2000 km (1250 miles). See page 19.

²⁾ 70 km.p.h. (45 m.p.h.) with overdrive engaged.

OPERATING INSTRUCTIONS

Starting the engine

Move the selector lever either to the "P" or "N" position. The starter inhibitor switch is automatically disconnected if the selector lever is moved to any of the other positions. The selector lever can be moved freely between the "N" and "D" positions, while the other positions are provided with a gate. For this reason, the selector lever must first be lifted towards the steering wheel before it can be moved into any of the other positions. If the car is temporarily stopped and the selector is moved to the "R", "D" or "L" position, apply the hand-brake or the footbrake to stop any tendency for the car to "creep".

Selecting

"D" position is normally used for driving forwards. The car starts then in 1st gear and automatically shifts up with increased speed. When the speed reduces, downshifting takes place automatically.

The "L" position, the low-speed position, means that the transmission operates only in 1st or 2nd gear. If the selector is moved to the "L" position during driving, there is immediate downshifting to 2nd gear. Should the speed drop below 10 km.p.h. (6 m.p.h.), 1st gear is engaged.

Upshifting will not take place when the selector is in the "L" position.

If upshifting to 2nd or 3rd gear is required, the selector must be moved to the "D" position. The "L" position should be used as follows:

1. In order to obtain immediate manual downshifting.
2. In order to obtain powerful engine braking when required, e.g., on steep grades.
3. In order to obtain high engine speed if required.

"N" position is the neutral position, i.e., no gear is engaged.

"R" position is used for reversing.

"P" position is used for parking either with the engine stopped or running. When parking on a hill, the parking brake should also be applied. Do not use the "P" position when the car is rolling.

Driving

Select the position and release the parking brake so that the car starts to roll slowly. For normal acceleration, the accelerator pedal should not be depressed to the bottom. If rapid acceleration is required, depress the accelerator pedal fully to the bottom, past the noticeable resistance in the lower accelerator pedal position. This method, so-called kick-down, permits the transmission to downshift at speeds below approx. 105 km.p.h. (65 m.p.h.), whereby maximum acceleration is reached.

With kick-down, shifting down to 2nd gear takes place at speeds between 50 and 105 km.p.h. (30 and 65 m.p.h.) and to 1st gear below 50 km.p.h. (30 m.p.h.).

Upshifting to 2nd gear at kick-down takes place at 65 km.p.h. (40 m.p.h.) and to 3rd gear at 115 km.p.h. (70 m.p.h.).

The car is stopped in the normal way by releasing the accelerator pedal and applying the footbrake. The selector need not be touched.

If the car gets stuck in snow, loose sand, etc., it can be rocked free by moving the selector alternately between the "D" and "R" position under even, light accelerator pedal pressure.

Manual operation

To a limited extent, the automatic transmission can be operated manually. Starting then takes place with the selector in the "L" position. Upshifting to 2nd gear follows when the selector is moved to "D" and then rapidly back to "L". By moving the selector to the "D" position 3rd gear is obtained. By means of kick-down, either earlier downshifting or delayed upshifting can be obtained if so desired.

Do not select the "P" or "R" position when the car is moving.

Do not select "D", "L" or "R" position at a higher engine speed than idling when the car is stationary.

Do not select the "L" position at speeds above 115 km.p.h. (70 m.p.h.).

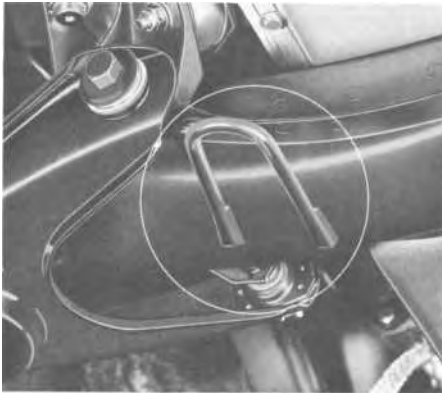

Towing

If the car has to be towed or if it has to do the towing, the tow line should be attached to one of the towing eyelets fitted underneath the car. At the front, the towing eyelet is situated at the right-hand side (left picture) on the front axle member, and the rear eyelet on the right spare wheel housing (right picture). During towing, the tow line should be kept stretched to avoid unnecessary jerking. When towing a car with automatic transmission, the selector should be in the "N" position. If a fault in the automatic transmission is suspected or if the level is too low, the propeller shaft be disconnected before towing.

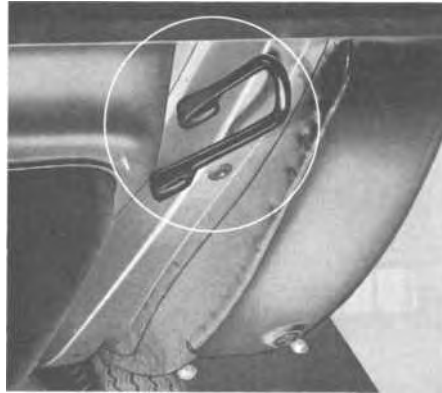

Starting by towing

The towing car should start smoothly and be driven at even speed in 2nd gear. Switch on the ignition, and pull out the choke if the engine is cold.
 Manual gearbox: Engage 3rd or 4th gear and gradually release the clutch pedal. Once the engine starts running, depress the clutch pedal.
 Automatic transmission: Place the selector in "N" position. At a suitable speed, move the selector to the "L" position. The engine should then start.

BRAKING

When driving in the rain or through pools of water, even when washing the car, water may splash up onto the brake discs and linings. This may alter the frictional properties of the linings.

The brake linings, however, dry fairly quickly with braking, but sometimes there may be a certain delay in the braking effect.

If you drive long stretches in the rain or slush, lightly depress the brake pedal now and again to warm up the linings and thus dry them. This should also be done when you drive your car immediately after washing it.

TECHNICAL DESCRIPTION

Engine compartment

1. Radiator
2. Battery
3. Voltage regulator
4. Air preheating unit
5. Alternator
6. Air cleaner
7. Carburettors
9. Oil filler cap
9. Fuel filter
10. Oil dipstick
11. Distributor
12. Ignition coil
13. Starter motor
14. Brake servo cylinder
15. Brake fluid container
16. Windscreen washer motor and container
17. Engine compartment lighting
18. Relay for rear lights
19. Relays for horn
20. Step relay for main beam and dipped lights
21. Relay for foglights
22. Fusebox for foglights
23. Steering box
24. Cooling system expansion tank

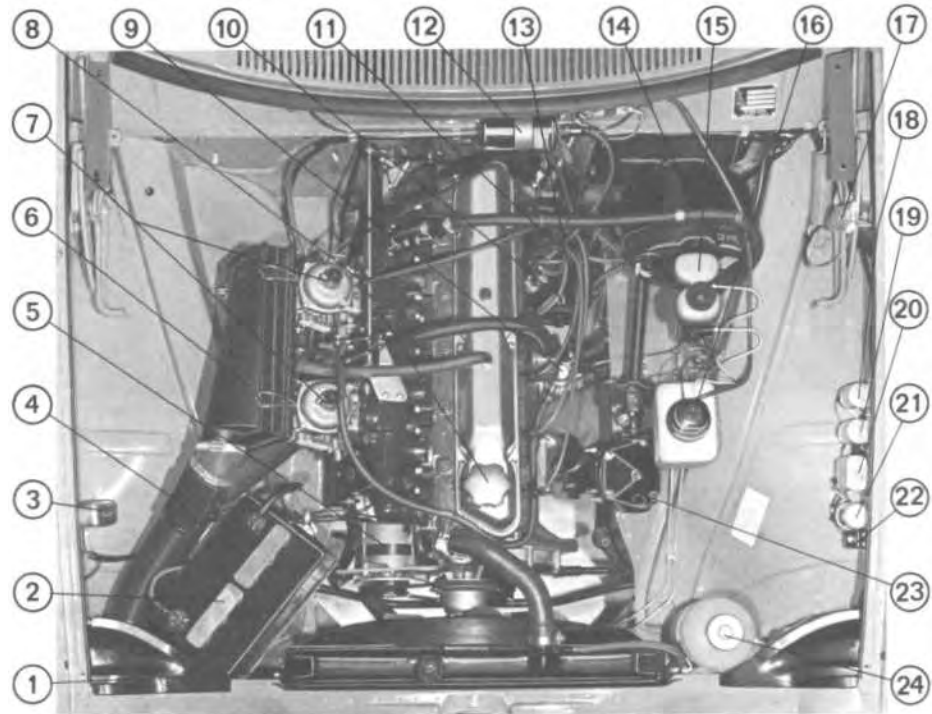

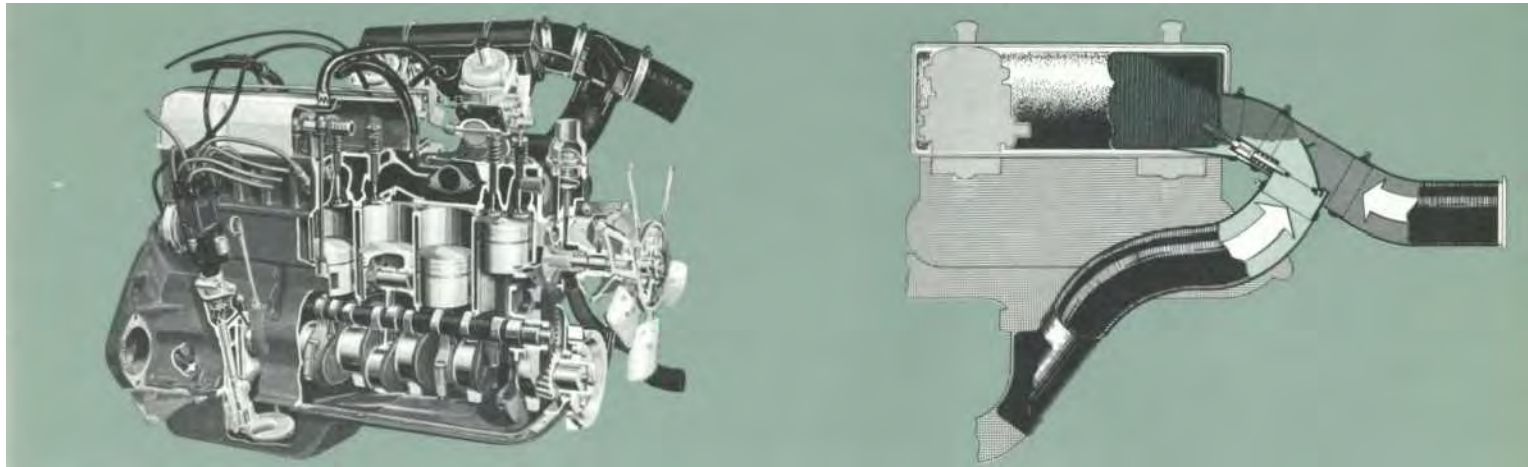

ENGINE

The B 30 A type engine is a six-cylinder, water cooled carburettor unit with overhead valves. The engine has a very rigid cylinder block made of special cast iron and is cast in one piece. The cylinder liners are machined directly in the block. The cylinder head has separate inlet and exhaust ports, one for each valve.

The statically and dynamically balanced crankshaft is carried in seven main bearings.

Lubricating system

Engine lubrication is taken care of by a gear pump located in the oil sump. The

pump is driven by a gear from the camshaft. From the pump the oil is forced through the full-flow type oil filter and then along oilways to the various lubricating points. A relief valve is built into the oil pump and prevents the oil pressure from reaching excessively high values. The oil filter is of the full-flow type, that is, all the oil passes through the filter before continuing on to the engine lubricating points.

Fuel system

The engine is fitted with twin carburettors of type Zenith-Stromberg. The diaphragm-

type fuel pump draws fuel from the tank and pumps it to the carburettors. A filter built into the fuel pump removes any impurities in the fuel.

On certain markets the vehicle is fitted with an evaporative control system which takes care of fumes from the carburettors and fuel tank.

Air preheating

The engine has thermostatically controlled air preheating. This keeps the intake air temperature constant and thus counteracts ice forming in the carburettors and makes for shorter warming-up after cold starting.

TECHNICAL DESCRIPTION



Exhaust emission control

The engine is fitted with an exhaust emission control system which produces a more exact and leaner mixture ratio between fuel and air resulting in a more complete combustion and thereby cleaner exhaust gases.

The system consists of specially adapted carburetors and an intake manifold provided with a preheating chamber and control throttles.

When driving at low speed, the throttles are closed so that the fuel-air mixture passes the preheating chamber.

Cooling system

The cooling system is of the sealed pressure type and incorporates a circulation pump. When the engine is cold the coolant circulates only inside the engine. As the engine warms up, a thermostat valve starts opening the outlet to the radiator.

A special expansion tank prevents air from circulating with the coolant as this would cause corrosion in the cooling system. The fan is driven by a slip-coupling which keeps the fan speed at about max. 2500 r.p.m.

POWER TRANSMISSION

Clutch

The function of the clutch is to transmit the power from the engine to the gearbox. The clutch is of the single dry plate type. Pressure on the pressure plate is obtained from a diaphragm spring which in turn is controlled mechanically by the clutch pedal via the throw-out yoke. (Hydraulic operation for vehicles with right-hand drive.

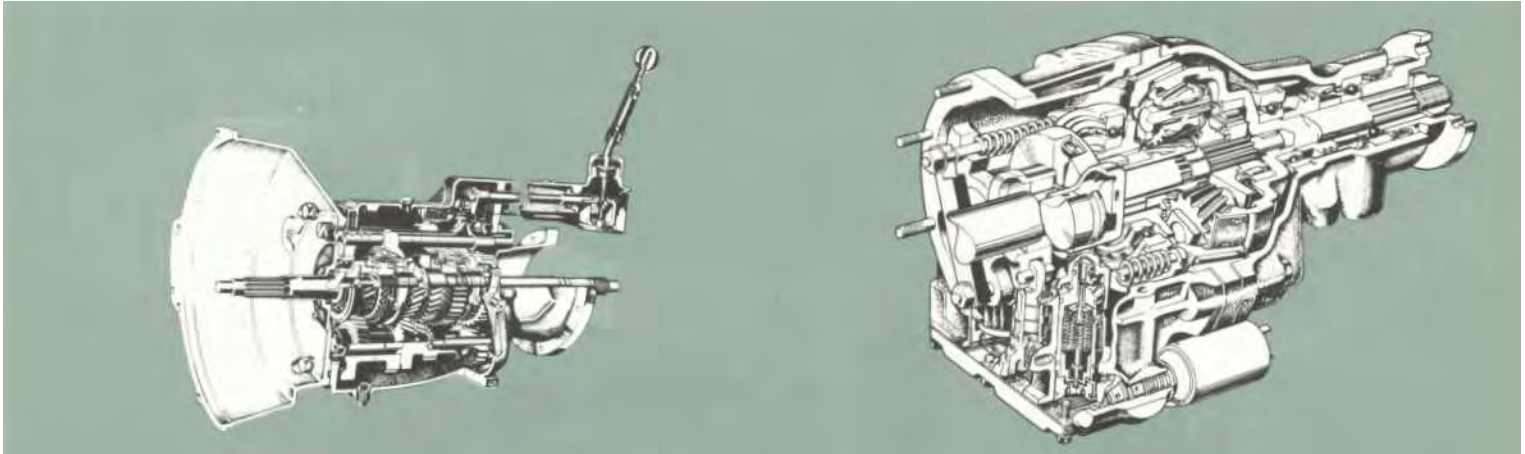

Gearbox

The gearbox has synchromesh on all the forward gears. Due to the generously dimensioned synchronizing rings the gearbox has smooth gear-changing.

As alternative the Volvo 164 can be fitted with a fully automatic transmission, BW 35.

Overdrive

For certain markets, the Volvo 164 model is fitted with an overdrive (see upper right) which makes it possible to reduce engine speed while maintaining road speed. This is less wearing on the engine and saves fuel at the same time.

Propeller shaft

The propeller shaft, which is the connecting link between the gearbox and the rear axle, is divided into two sections. The forward section is flexibly mounted at its rear end in a bearing suspended in a rubberized ring.

TECHNICAL DESCRIPTION



Final drive

Engine torque is transmitted via the propeller shaft to the rear wheels through the final drive. The final drive is of the hypoid type, that is, the drive pinion lies below the centre line of the drive shafts.

Differential lock

On certain markets, a differential lock can be obtained as extra equipment. A rear axle with a differential lock automatically

transmits the tractive power to the wheel having the best road grip when a wheel begins to spin. Except for the differential unit, the rear axle is similar in design to a conventional rear axle.

Warning. Do not rotate a jacked-up rear wheel if the other rear wheel is still on the ground. Due to the differential unit, there is still drive on the wheel in contact with the ground. Rotating the jacked-up rear wheel would thus move the other rear wheel and may cause the car to topple off the jack.

Rear axle

The rear axle is carried on two support arms, the front ends of which are bolted to the body. The rear axle casing is secured to the support arms by means of levers. Two torque rods are journalled on the casing and the body. A torque rod prevents lateral movement of the body and rear axle in relation to each other.



FRONT END AND STEERING

Front end

The car has independent front suspension. The front suspension units are mounted on a strong box member. The member is bolted firmly to the front section of the body. The front wheels are journalled in tapered roller bearings. The front springs consist of coil springs in which telescopic shock absorbers are fitted. The car is provided with stabilizers secured to the lower control arms and to the body.

Mechanical steering

Certain variants of the Volvo 164 are fitted with mechanical steering. The steering is of the cam-and-roller type. Movements of the steering wheel are transmitted via the worm on the steering column to the ball nut for the pitman shaft, which in turn operates the wheels through a linkage system.

Servo steering

The servo cylinder and guide valves are built into the cam-and-roller type steering gear. When the steering wheel is turned, the guide valves direct the pressure oil from the servo pump to one of the sides of the piston in the servo cylinder. The resultant pressure on the piston side affected assists in turning the steering wheel.

TECHNICAL DESCRIPTION

ELECTRICAL SYSTEM

The electrical system is of the 12-volt type and is fitted with a voltage-regulated alternator. The starter motor is operated by means of the ignition switch. This switch is also the main switch for the rest of the electrical system. The cables to the headlights, parking lights, interior lighting, radio, engine compartments and luggage compartment, however, are not controlled by the ignition switch, but can be switched on and off without the ignition key being in position.

Lighting

The front lighting consists of two headlights (full and dipped beam), two extra foglights (on certain markets) together with two turn indicators and a parking light. At the rear, the lighting consists of two tail lights, turn indicators, brake warning lights and reversing lights. There are also two lights for the rear license plate. The interior lighting consists of a roof light and one in the glove locker. On certain markets the vehicle is fitted with side marker lights mounted on the sides of the mudguards. Both the engine compartment and luggage compartment are fitted with lights, which function automatically when the bonnet or luggage compartment lid is opened.

For replacement of bulbs, see pages 46, 47 and 48.

1. Turn indicator lights 32 Cp
2. Parking lights 5 W
3. Dipped lights 40 W
4. Mainbeam lights 45 W
5. Distributor
6. Battery 12 V 60 Ah
7. Connection to instrument
8. Terminal
9. Part of 6-pol. terminal block
10. Horn ring
11. Ignition coil
12. Horn relay
13. Starter motor 1 h.p.
14. Brake warning switch
15. Resistance
16. Relay for elec. heater rear window
17. Cigarette lighter
18. Stop relay for mainbeam/dipped lights and headlight flasher
19. Alternator 12 V 55 A
20. Horn
21. Control lamp for mainbeam 1.2 W
22. Fusebox
24. Engine compartment lighting 18 W
25. Charging control
26. Switch for glove locker lighting
27. Bulb for glove locker lighting
28. Flasher unit and emergency warning flasher light switch
29. Brake switch
30. Warning lamp for parking brake 1.2 W
31. Warning lamp for oil pressure 1.2 W
32. Warning lamp for charging 1.2 W
33. Oil pressure sensor
34. Switch for turn indicators and flasher signal
35. Voltage regulator
36. Fuel gauge
37. Temperature gauge
38. Temperature pick-up
39. Warning lamp, flasher 1.2 W
40. Instrument panel lighting 2x3 W
41. Lighting for heater controls 3x1.2 W
42. Luggage compartment lighting 18 W
43. Windscreen wipers
44. Heater
45. Windscreen washer
46. Roof light 10 W
47. Heater switch
48. Rheostat for instrument and wiper switch
49. Rheostat for instrument lighting
50. Lighting switch

51. Ignition switch
52. Door switch
53. Switch for elec. heated rear window
54. Elec. heated rear window
55. Switch for parking brake control
56. Fuel level indicator unit
57. Reversing lights 15 W
58. Brake lights 25 W
59. Rear lights 5 W
60. License plate light 2x5 W
61. Warning lamp for overdrive 1.2 W
62. Switch for overdrive
63. Switch for overdrive on gearbox
64. Solenoid for overdrive
65. Switch for automatic transmission BW 35
66. Switch for reversing lights
Only for M 400 and M 410 gearboxes
67. Relay for reversing lights on M 400
M 410 and starter relay on BW 35
68. Side marker lights 4 cp (only U.S.A.)
69. Warning buzzer for ignition switch (only U.S.A.)
70. Door switch, left
71. Foglights 55 W
72. Fusebox for foglights
73. Relay for foglights
74. Switch for foglights

COLOUR CODE

SB BLACK
W WHITE
Y YELLOW
GN GREEN
GR GREY
R RED
BR BROWN
BL BLUE

Differences may occur for different markets.

The wiring diagram shows the foglights connected across the parking and dipped lights. On certain markets they are connected across the parking and main beam lights. On this occasion the brown lead between the foglight relay (73) and the stop relay (18) is connected to 56-b. If the foglights are connected across only the parking lights, the lead goes to 56.

TECHNICAL DESCRIPTION

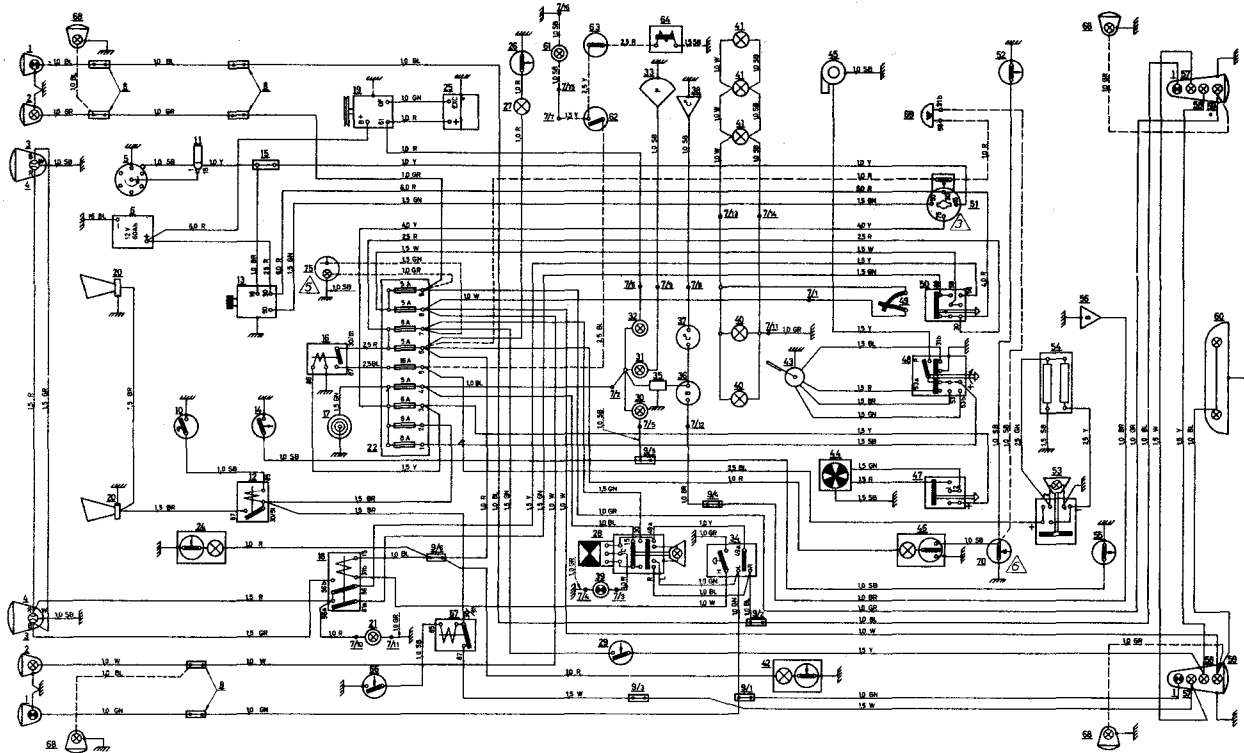
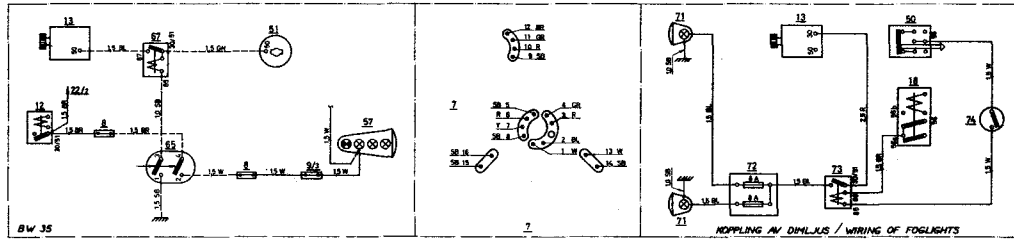

TECHNICAL DESCRIPTION

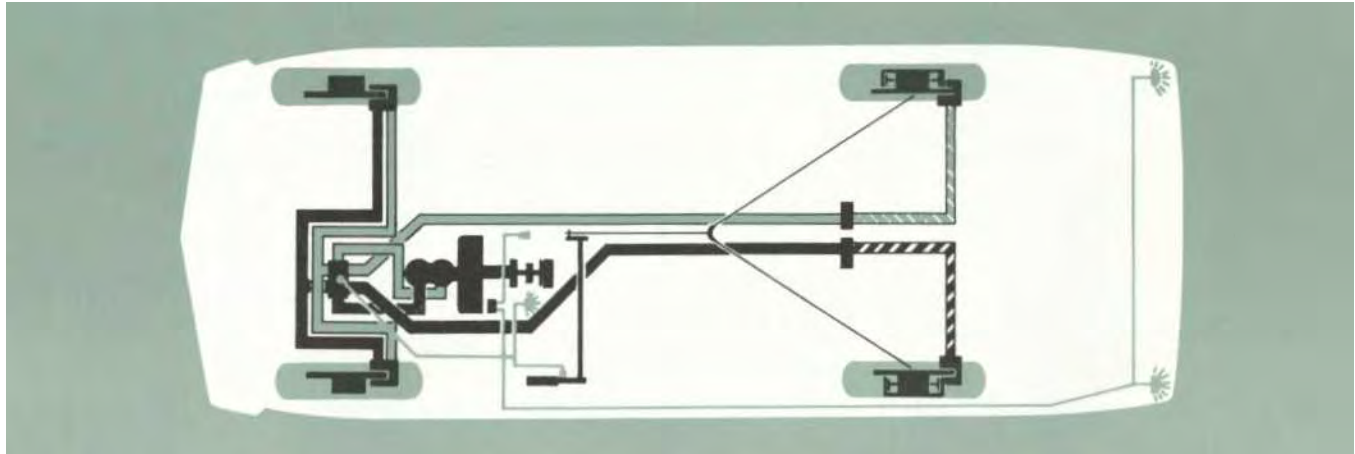

BRAKES

The brake system is of the two-circuit type with disc brakes all round. The system is provided with a tandem-type master cylinder and a directly-operating booster cylinder. When the brake pedal is depressed, the master cylinder is operated mechanically via the booster cylinder, this boosting the pedal force about four times. The brake pressure is transmitted hydraulically from the master cylinder through the brake lines to the wheel cylinders. The pistons in these are then pressed outwards and operate the brake pads. The pressure lines to

the rear wheel brakes are provided with reducer valves which prevent locking of the car wheels.

The principle of the two-circuit system is that both the front wheels are connected to one rear wheel, that is, should there be a failure in one of the circuits, there is always braking power on both front wheels and the other rear wheel. At normal pedal pressure the braking effect of each of the circuits is 50 %, but when pedal pressure is increased, about 80% of the full braking power can be obtained in the one circuit.

This provides maximum safety and prevents lateral dragging and rear-end lurching. With the engine stopped, the booster assists the braking a further 2 or 3 times after which the pedal pressure must be increased about four times in order to obtain a braking power corresponding to the braking power available with the engine running.

The parking brake operates the rear wheels mechanically as the brake discs have also been designed as brake drums in order to incorporate the shoes for the handbrake.



GENERAL

Before the vehicle was delivered from the factory it was subjected to a very thorough inspection. Your dealer, in his turn, carried out a further delivery inspection in accordance with the specifications of the Volvo Factory. In addition to this there is the service inspection after 2500 km (1500 miles) when the oil in the engine, gearbox and final drive are changed. Servicing of the vehicle should thereafter follow the routine in the service book which is based on a service inspection after every 10.000 km (6000 miles). The simplest way to provide the vehicle with the servicing it re-

quires is to have all the servicing done by a Volvo workshop. You will then have the work specified in the service book carried out in accordance with recommended prices and the workshop stamp in the service book will show when the vehicle was serviced.

When the car was being designed particular attention was given to the "safety details" (e.g. front end, brakes and steering). They are calculated to withstand the severest stresses with a wide safety margin. However, if you use your car for hard driving, you should take the precau-

tion of checking these parts during the useful lifetime of the car, for instance, when front-end components are being re-conditioned.

If you prefer to carry out the simpler servicing procedures yourself or if you are sometimes obliged to have them done by a workshop outside the Volvo organization, this chapter contains some advice as to when and how they should be carried out. For the sake of convenience, the servicing procedures have been summarized in a maintenance scheme in the next two pages.

SERVICING

MAINTENANCE SCHEME

In the maintenance scheme below the servicing procedures have been given certain numbers which refer to the detailed descriptions on the following pages.

Some of the work must be carried out by skilled mechanics or requires the use of special tools and these have been marked 0.

Operation	Carried out every		
	10,000 km 6000 miles	40,000 km 25,000 miles	See note below
LUBRICATION			
1. Lubricate body	●		● Once a year
2. Check oil level in engine			● When filling up with fuel
3. Change oil in engine	● ¹⁾		See page 37
4. Carburettors, filling oil in the damping cylinders	●		
5. Check oil level in gearbox	●		
6. Change oil in gearbox		● ¹⁾	
7. Check oil level in overdrive	●		
8. Change oil in overdrive		0 ¹⁾	
9. Check oil level in automatic transmission	●		
10. Check oil level in rear axle	●		
11. Change oil in rear axle			● ²⁾
12. Check oil level in rear axle with differential lock	●		
13. Change oil in rear axle with differential lock			● ²⁾

¹⁾ Also after the first 2500 km (1500 miles) during running-in.

²⁾ Only after the first 2500 km (1500 miles).

Operation	Carried out every		
	10,000 km 6000 miles	40,000 km 25,000 miles	See note below
14. Check oil level in steering box	●		
15. Check oil level in servo steering	●		
16. Check brake fluid level (Also clutch fluid level, with r-h drive vehicle)			● When filling up with fuel
ENGINE			
17. Servicing of crankcase ventilation		●	
18. Replace oil filter	○		
19. Clean fuel filter	●		
20. Change air cleaner filter		●	
20a. Replace foam plastic filter for evaporative control unit ³⁾		○	
21. Check valve clearances	○		
22. Carry out compression test	○		
23. Check fan belt	○		

³⁾ Concerns only certain markets.

In addition to the servicing procedures mentioned in this scheme you should also check regularly the following from the point of view of traffic safety:

- a) lighting, including brake warning light
- b) turn indicator lights
- c) horn

Operation	Carried out every		See note below
	10,000 km 6000 miles	40,000 km 25,000 miles	
24. Check coolant level			<ul style="list-style-type: none"> ● When filling up with fuel ● Every other year
25. Change coolant			
26. Check sparking plugs	○		
27. Check distributor contact breakers	○		
28. Check ignition timing setting	○		
ELECTRICAL SYSTEM			
29. Check electrolyte level in battery			● Every other week
30. Check state of charge of battery	○		
31. Check headlight alignment	○		
POWER TRANSMISSION			
32. Check release arm travel	○		
33. Check propeller shaft	○		○ Once a year

Operation	Carried out every		See note below
	10,000 km 6000 miles	40,000 km 25,000 miles	
BRAKES			
34. Check turn brakes	○		
35. Replace booster cylinder air filter and overhaul brakes			○ Every 3 years
FRONT END			
36. Check front wheel alignment	○		○ Once a year
37. Check ball joints, steering rods etc.	○		○ Once a year
WHEELS AND TYRES			
38. Check tyre pressure			● Every other week
BODY			
39. Washing			See page 52
40. Polishing			See page 52
41. Anti-rust treatment			See page 53
42. Cleaning			See page 53

SERVICING

LUBRICATION

Chassis maintenance

To simplify maintenance of your Volvo, the vehicle has been equipped with ball joints, steering rods and propeller shafts of such a construction that they do not require regular lubrication. This has been possible due to the fact that points that normally require lubricating have been packed with very durable grease at the factory and then carefully sealed, thus obviating the need for subsequent lubrication.

However, to ensure that these parts are functioning properly, it is necessary to inspect their seals and rubber sleeves thoroughly after every 10.000 km (6000 miles) or at least once a year.

Oil in the gearbox, final drive, steering box, servo steering and carburettors should be changed or the oil level checked after every 10.000 km (6000 miles) suitably in connection with the 10.000 km (6000 miles) inspection. The measures taken in this inspection are also to be found in the lubricating chart.

Always use only first-class lubricant of a well-known make. The right lubricants in the right quantity at the right time will increase both the lifetime and the reliability of your car.

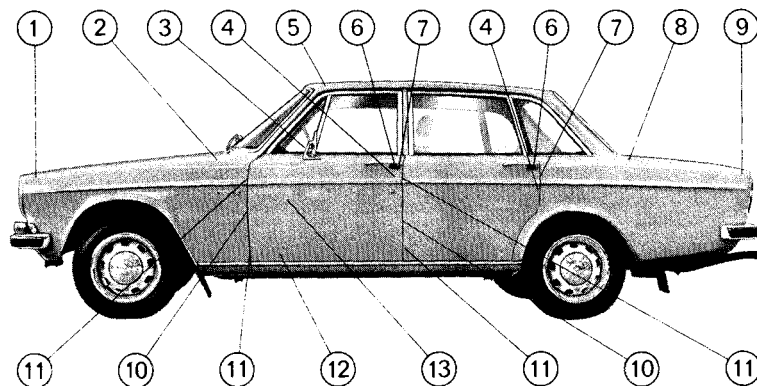

1 Body lubrication

In order to avoid rattle and unnecessary wear, the body should be lubricated once a year. The hinges on the bonnet, doors and luggage compartment lid as well as door stops should be lubricated every 10.000 km (6000 miles)*). Moreover, during the winter months the locks on the doors and luggage compartment lid should be given some anti-freeze to prevent them from freezing up.

*) Included in the 10,000 km (6000 miles) inspection.

No. Lubricating point

1. Bonnet catch
2. Bonnet hinges
3. Ventilator window catches and hinges
4. Catches
5. Roof opening wind breaker
6. Door handle lock buttons
Key holes
7. Door lock outer sliding surfaces
8. Luggage compartment hinges*
9. Luggage compartment lock
Key holes
10. Door checks*
11. Door hinges*
12. Driving seat slide rails and catches
13. Window lifts
Locks
(Accessible after door upholstery panels have been removed)

Lubricant

Paraffin wax
Oil)

Oil
Molybdenum --
disulphide grease
Oil)

Paraffin wax
Silicon wax

Paraffin wax

Oil
Oil
Silicon oil
Paraffin wax
Grease

Paraffin wax
Oil and grease
Silicon grease

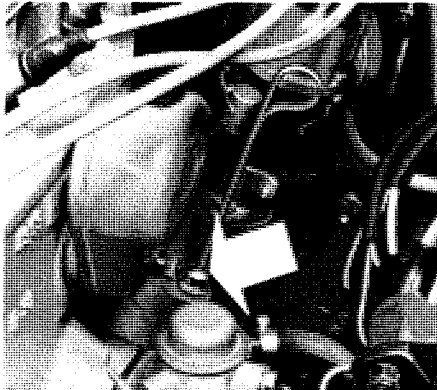

2 Check the oil level in the engine

The oil level in the engine should be checked each time the fuel tank is filled. The check should be carried out with the engine switched off but warm and, in order to obtain comparable values, about 1 minute after it has been stopped. Wipe the dipstick before measuring. The oil level should be between the two marks on the dipstick. It must never be permitted to go down below the lower mark but, on the other hand, it should not be above the upper mark since oil consumption will then be abnormally high. If necessary, top up by filling through the oil filler hole on the

rocker-arm casing with new oil of the same type already in the engine.

3 Change oil in engine

With a new or newly reconditioned engine, the oil should be changed after the first 2500 km (1500 miles). Subsequent oil changing is according to the intervals given below. The intervals will depend to a great extent on the type of oil used. For engine lubrication, oil quality "For Service MS", is to be used. As far as viscosity is concerned, multigrade oil is recommended. These oils are better suited for demanding driving conditions, for example continuous driving in city traffic with incessant stopping and starting and with lengthy idling periods.

For engine oil with viscosity SAE 10 W-30 (multigrade), 10 W-40, 10 W-50 or 20 W-50 the oil should be changed every 10,000 km (6000 miles), or at least once a year.

If engine oil with viscosity SAE 10 W (singlegrade), 20/20 W or 30 is used, the oil should be changed every 5000 km (3000 miles), or at least twice a year.

At very low temperature (below -20°C, -4°F) multigrade oil SAE 5 W-20 is recommended. However, this oil should not be used when the temperature is continuously above 0°C (32°F).

The old oil is drained off by removing the drain plug on the sump. Drainage should take place after driving when the oil is still warm.

Viscosity Oil grade	Temperature range	Oil change intervals km (miles)	Oil capacities
SAE 10 W-30 } 10 W-40 } 10 W-50 } 20 W-50 } "For Service MS"	all year round for all temp. above -10°C (14°F)	10,000 (6000) (or however at least once a year)	No oil filter 5.2 litres 9.2 Imp. pints 11.0 US pints
SAE 10 W } 20/20 W } 30 } "For Service MS"	below -10°C (14°F) between -10°C and +30°C (14 and 90°F) above 30°C (90°F)	5000 (3000) (or at least twice a year)	With oil filter 6.0 litres 10.6 Imp. pints 12.6 US pints

1) Change the oil after the first 2500 km (1500 miles) during running-in.

SERVICING

4 Carburettors

At each oil change check that the oil level in the centre spindle of the carburettors is about 6 mm (1/4") from the top of the spindle. If it is not, fill up with oil ATF Type F (Automatic Transmission Fluid). If this oil is not available, use Type A or Dexron.

The carburettors are adjusted and tested in a test bench at the factory with a CO-gauge. No adjustment of the carburettors is required other than when carrying out repairs to them.

Oil, ATF Type F
(if unavailable, Type A or
Dexron)

5-6 Gearbox M 400

The oil in the gearbox should be checked after every 10,000 km (6000 miles). The oil level should be up to the filler hole. If necessary top up with the recommended oil.

After every 40,000 km (25,000 miles) the oil in the gearbox should be changed. In the case of a new or reconditioned gearbox the oil should also be changed after the first 2500 km (1250 miles) and the gearbox thoroughly flushed with the same type of oil subsequently used. The old oil should be drained off immediately after the vehicle has been run while the oil is still warm.

Oil grade	Viscosity	Oil capacity
Gear oil alt.	SAE 90 At temperatures below -10°C (14°F) SAE 80	0.6 litre 1.1 Imp. pints 1.3 U.S. pints
Engine oil	SAE 40	

7-8 Gearbox with overdrive M 410

For cars fitted with an overdrive, the oil level should be checked and the oil changed parallel with similar procedure for the gearbox. The overdrive and the gearbox have a common oil level and oil filler hole. Make sure when topping-up that the oil runs over into the overdrive. The oil is drained out by removing the gearbox drain plug and the cap for the overdrive oil strainer. At each oil change the oil filter of the overdrive should be cleaned. This should be done by a Volvo workshop.

Oil grade	Viscosity	Oil Capacity
Engine oil	SAE 30 or Multigrade SAE 20 W-40	1.4 litres 2.46 Imp. pints 2.95 U.S. pints

9 Automatic transmission BW 35

The oil level in the automatic transmission should be checked every 10,000 km (6000 miles). Under the bonnet (hood) at the rear of the engine there is a marked dipstick located in the filler tube. Note that the dipstick has different marks for a hot and cold transmission. The oil level should be checked with the car on level ground. With the engine idling in position "P", the level should be between the upper and lower graduation marks on the dipstick. If topping up is required, oil under the designation Automatic Transmission Fluid, Type F, should be used. If this oil is not available, use Type A or Dexron.

The dipstick should be wiped with a nylon cloth, paper or chamois leather. Cloths which leave residues on the dipstick must be avoided.

Oil grade	Oil capacity
ATF Type F (if unavailable, Type A or Dexron)	8.2 litres 14.4 Imp. pints 17.4 U.S. pints

10-11 Final drive

Check the oil level in the final drive every 10,000 km (6000 miles). The oil should reach up to the filler hole. If necessary top up with oil. The oil in the final drive should first be changed after 2500 km (1250 miles). The oil is drained by removing the bottom plug in the final drive casing. The oil should be drained when it is warm. Clean the bottom plug thoroughly. After this only the oil level need be checked and topped up when necessary.

Oil grade	Viscosity	Oil capacity
Rear axle oil MIL-L-2105B	SAE 90 At temperatures continuously below -10°C (+14°F), SAE 80	1.6 litres 2.82 Imp. pints 3.38 U.S. pints

12-13 Differential lock

Cars fitted with a differential lock are delivered from the factory with a rear axle oil according to the American Military Standard MIL-L-2105 B provided with an additive for rear axles with differential lock. A similar type of oil should be used for subsequent topping-up and changing. Oil level checking and oil changing are to be carried to at the same intervals and in the same way as for a rear axle without differential lock.

Rear axle oil MIL-L-2105 B with additive for differential lock.

SERVICING

14 Steering box (mechanical steering)

The oil level in the steering box should be checked after every 10,000 km (6000 miles). The oil level should be up to the filler plug. If necessary, top up with new oil. As a rule, the oil in the steering box does not need to be changed except during overhauling. Should the oil for any reason need to be changed, the old oil should be sucked up by means of an oil syringe which is inserted into the filler hole.

15 Servo steering

The oil level in the servo steering should be checked every 10,000 km (6000 miles). Before checking wipe the oil container clean. Then remove the cap and check the level with the engine not running. The oil level should be about 5-10 mm (1/4") above the level mark in the container. If the level is lower than this, top up with oil, with the engine stopped to prevent air from being sucked into the container. Start the engine and recheck the oil level, which should now fall to the level mark. When the engine stops, the level should rise to about 5-10 mm (1/4") above the mark. The oil and filter in the servo steering do not need replacing other than during repairs or reconditioning.

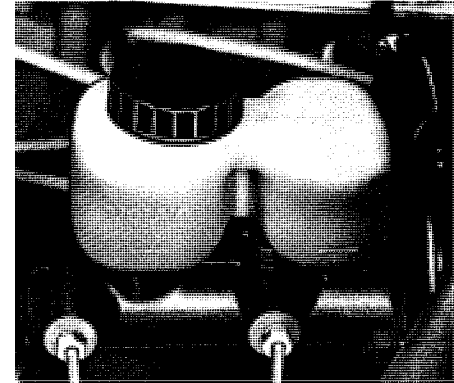

16 Brake fluid

The brake system is fitted with a tandem-type brake fluid container with a section for each circuit but with the same filler hole. The brake fluid level should be between the "Max" and "Min" marks. (On vehicles with right-hand drive the clutch fluid container should be filled almost to the top with brake fluid.)

Oil grade	Viscosity	Oil capacity
Hypoid oil	SAE 80 All year round	0.6 litre 1.1 Imp. pints 1.3 U.S. pints

Oil grade	Oil capacity
ATF Type A or Dexron	1.2 litres 2.11 Imp. pints 2.53 U.S. pints

Only brake fluids meeting the requirements according to SAE 70 R 3, SAE 70 R 3 (J 70 B) or SAE J 1703 may be used for the hydraulic brake system.

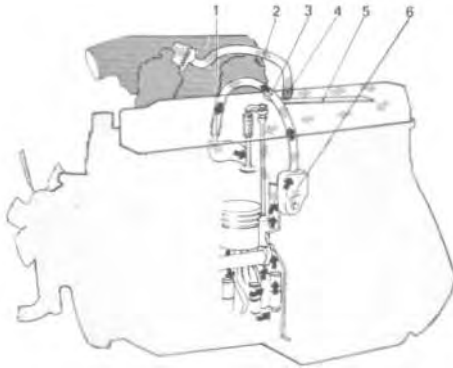

ENGINE

17 Crankcase ventilation

The engine is provided with positive crankcase ventilation which prevents the gases in the crankcase from being released into the atmosphere. Instead, they are sucked into the intake manifold and take part in the combustion process whereupon they are blown out through the exhaust pipe together with the other combustion gases. Every 40,000 km (25,000 miles) remove and clean the nozzle (1), the hoses (2 and 3) and the flame protector (4). Rubber hoses should also be replaced if they are in a poor condition.



18 Oil filter

The engine is fitted with a full-flow type oil filter, which means that all the oil passes through the filter on its way from the oil pump to the various lubricating points. Impurities in the oil are collected in the filter and gradually block it. For this reason, the filter must be changed every 10,000 km (6000 miles). Scrap the old filter then. If the oil filter is replaced without the engine oil being changed, the engine should be topped up with 0.8 litre (1.4 Imp, pints = 1.7 US pints) of oil.



19 Fuel filter

The fuel filter should be cleaned after every 10,000 km (6000 miles). Loosen the plug and clean the filter in the plug. Check that the gasket is not damaged and make sure that it seals properly when the plug with filter is re-fitted.

SERVICING



20 Replacing the air cleaner paper filter

The air cleaner consists of a plastic cover with replaceable paper filter insert. The insert should be replaced after every 40,000 km (25,000 miles). Replacement should be carried out more frequently if the driving conditions are often dusty. No other kind of servicing is required outside these intervals.

To replace release the tensioning clips securing the air cleaner cover. The cover can then be opened so much that the insert is accessible for replacement.

20 a Replacing foam plastic filter for evaporative control system

On vehicles fitted with an evaporative control system, the foam plastic filter in the holder on the cowl to the right in the engine compartment should be replaced every 40,000 km (25,000 miles).

21 Valves

The valve clearances should be checked after every 10,000 km (6000 miles). This check should be carried out by a workshop.

22 Compression test

To get some idea of the condition of the engine, a compression test should be made after every 10,000 km (6000 miles). This test should preferably be carried out by a workshop.

23 Fan belt

The fan belt tension should be checked every 10,000 km (6000 miles). Due to wear or dirt, this belt can start slipping with poor cooling and poor alternator output as the result.

The check can suitably be carried out by a Volvo workshop.

To test the tension provisionally press in the fan belt at a point midway between the alternator and the fan. It should be possible to press down the belt about 10 mm ($\frac{3}{8}$ ") with normal pressure (11.5-14 kp = 85-100 lb.ft.)



24 Check the coolant level

The cooling system must be well filled with coolant and not leak if it is to operate at maximum efficiency. Check the coolant level when filling up with fuel. The level should be between the "Max" and "Min" marks on the expansion tank.

The check should be carried out with particular thoroughness when the engine is new or the cooling system has been empty.

Do not remove the filler cap other than for topping-up with coolant. Frequent removal interferes with the coolant circulation between the engine and the expansion tank during engine warming up and cooling.

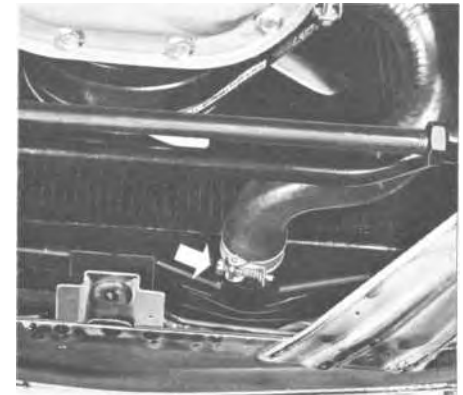

Top-up with coolant

Top up with coolant by filling the expansion tank when its level has gone down to the "Min" mark. Use 50% good quality anti-freeze mixed with 50% water all the year round and top up to the "Max" mark.

NOTE. Do not top up with water only.

Water by itself reduces both the rust-protective and anti-freeze qualities of the coolant. It can also cause damage to the cooling system if ice should form in the expansion tank.

Note. In countries with very warm climate where risk of frost is rare, ordinary water can be used in the cooling system.

25 Change the coolant

The coolant retains its properties for approx. 2 years when it should be changed. A suitable time to make the change is during the autumn to ensure against any damage by frost during the coming winter months. To drain the cooling system, open the drain tap located at the right-hand side of the engine and disconnect the hose attached to the bottom of the radiator. The expansion tank is emptied by removing it from its brackets and lifting it to a sufficient height so that the coolant flows into the radiator.

For cars fitted with an oil cooler for the engine oil, the plug underneath at the back of the oil cooler must be released.

Before filling with new coolant, flush the entire system with clean water.

The cooling system is filled with coolant through the filler opening on top of the radiator. When this is being done, the heater control should be set to max. heat to ensure that the entire system will be filled.

Fill the radiator to the top and fit on the cap. Then fill the expansion tank to the "Max" level or slightly above this.

Run the engine warm and then check that the radiator is full and that the coolant in the expansion tank is at "Max". If necessary, top up the system.

SERVICING

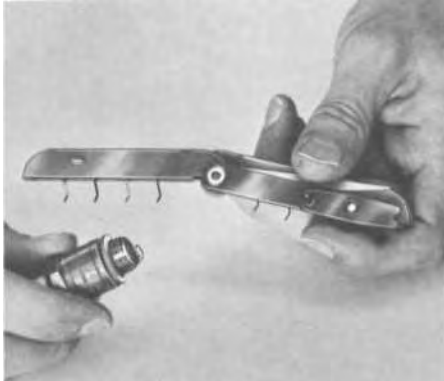

26 Check sparking plugs

The spark plugs should be removed and checked every 10,000 km (6000 miles). The electrode gap is adjusted to 0.7-0.8 mm (0.028-0.032"). Replace the spark plugs if the electrodes are very much burnt. With normal driving, the spark plugs can last for at least 20,000 km (12,500 miles).

When replacing a spark plug, make sure that the proper type is fitted. As standard, Bosch W 200 T 35 or corresponding of another make should be used.

If the car is driven, for example, in town traffic, Bosch W 175 T 35 or corresponding can be used. The spark plugs should preferably be tightened with a torque wrench. Tightening torque is 3.5-4.0 kpm (25-29 lb. ft.).

When changing the spark plugs, check that the suppresser connectors are in good condition. Cracked or damaged connectors should be replaced.

27-28 Ignition system

The distributor contact breaker gap and the engine ignition timing should be checked every 10,000 km (6000 miles). All adjusting work should be done by a workshop with the proper equipment. The distributor is one of the most sensitive units in the engine and careless handling can lead to decreased engine output and high fuel consumption or even serious damage to the engine



ELECTRICAL SYSTEM

29 Check the battery electrolyte level

To ensure that the battery functions properly, the electrolyte level should be checked regularly. A suitable time to do this is when the fuel tank is being filled. The electrolyte level should be up to the slit tubes. If the level is too low top up with distilled water. Never add too much distilled water since this can cause the acid to splash over and possibly damage the engine compartment. Never check the electrolyte level by lighting a match. The gases formed in the cells are highly explosive.

Fuel

Fuel with an octane value of 100 (ROT*) is primarily recommended for normal driving. Knocking or pre-ignition can occur if petrol with low octane value is used. However, if highway motoring is often involved, an octane value of at least 97 (ROT*) should be used.

In those countries where it is not possible to obtain fuel with 97 octane rating, the engine can be adjusted to a lower rating.

ROT* = Research Method.

30 Check the state of charge of the battery

The state of charge of the battery should be checked after every 10,000 km (6000 miles). The check is made with an hydrometer which shows the specific gravity of the battery acid (this varies with the state of charge of the battery). See page 58. At the same time, check also that the lead terminals are well tightened to the battery studs and smeared with grease. The battery should be firmly fixed. If necessary, wipe the lead terminals and terminal studs clean with a cloth or brush them with a wire brush and re-grease them.

31 Check headlight alignment

The alignment of the headlights should be checked in a workshop after every 10,000 km (6000 miles). Remember that the section of the road lit up by the headlights can vary according to the load in the vehicle.

This car is fitted with an alternator.

When changing the battery or when carrying out work involving the electrical system, the following should be observed:

1. A battery connection to the wrong terminal will damage the rectifiers. Before the connections are made, check the polarity of the battery with a voltmeter.
2. If extra batteries are used for starting, they must be properly connected to prevent the rectifiers from being damaged. The negative lead from the auxiliary battery for starting must be connected to the negative terminal stud of the car battery and the positive lead from the auxiliary battery for starting to the positive terminal stud.

3. If a rapid charger is used for charging the battery, the car battery leads should be disconnected. The rapid charger must never be used as an auxiliary unit for starting.

4. Never disconnect the battery circuit (for example, to change the battery) while the engine is running, as this will immediately ruin the alternator.

Always make sure that all the battery connections are properly tightened.

5. Before carrying out any electrical welding on the car, first disconnect the battery earth lead and all the cables to the alternator and voltage regulator. Make sure that the ends of the loose cables do not earth against the car framework. Insulate well if necessary.

SERVICING

Replacement of bulbs

The headlight bulbs should be changed every year, suitably during the autumn. When installing headlight bulbs, do not touch the glass with your fingers. The reason for this is that grease, oil or any other impurities can be carbonized onto the bulb and this could damage the reflector.

The following pages explain how the bulbs in the various lighting units are replaced. Make sure when fitting lamps that the guide pin on the socket fits into its corresponding recess.



Replacing the headlight bulbs

The headlight bulbs are replaced from inside the engine compartment in the following way:

1. Remove the protective cover over the space behind the headlight.
2. Remove the contact for the bulb holder and rubber sleeve.
3. Remove the spring which fixes the lamp holder in the correct position.
4. Lift out the bulb. When fitting the new bulb in the insert make sure that the guide pin engages in its notch. Do not touch the bulb glass with your fingers!





Replacing the bulbs for the front turn indicator flashers and the parking lights

Remove the two Philips screws which hold the glass. The bulbs can now be removed by pressing them inwards and then turning them a little anti-clockwise. The inner bulb is for the parking light, the outer for the flasher.

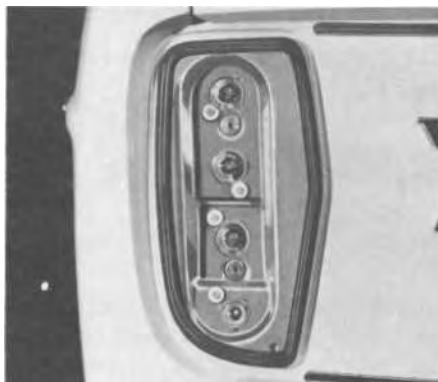

Replacing the bulbs for the rear turn indicator flashers, parking lights, stop lights and reversing lights

Remove the two Philips screws which hold the glass. The bulbs can now be removed by pressing them inwards and turning them slightly anti-clockwise at the same time. The top bulb is the flasher, the one under that is the reversing light, the next one under that the stop light and the one at the bottom the rear light. Make sure that the sealing strip fits well against the glass when it is refitted.



Replacing the bulbs for the license plate light

The two bulbs for the license plate light are mounted on a holder located under the luggage compartment locking device. Loosen the two screws which hold the glass and remove it. The bulb is now accessible for changing.

SERVICING

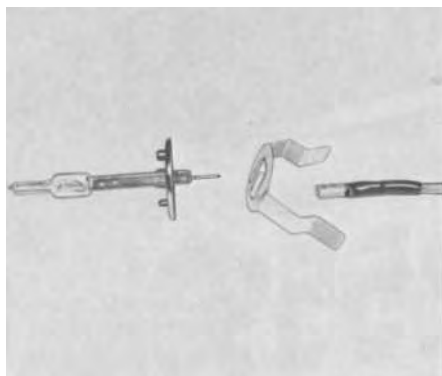

Replacing the foglight bulbs

The bulbs for the foglights are replaced from inside the engine compartment. Remove the protection covering the space over the headlight and foglight. Squeeze together the spring holding the bulb and lift out the spring and bulb. The bulb is now accessible for replacement. Because of the two bosses on the bulb socket, the bulb can only be fitted in one way.

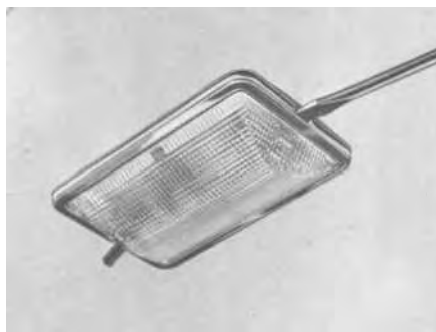

Replacing the bulb for the roof light

To replace the bulb for the roof light, remove the light glass by pressing a narrow screwdriver straight into the hole in the glass as shown in the picture. The glass can then be removed. The glass is replaced after the bulb has been changed by first hooking it securely to the switch and then pressing it up with the hand.

Replacing the bulb for the lights for the luggage and engine compartments

Slacken the screw holding the lamp shade. The bulb is now accessible for replacement.

Replacing the bulb for the glove compartment light

The bulb is mounted under the dashboard above the compartment lid. To remove the bulb, press it in a bit and then turn it anti-clockwise.

Replacing lamps for instrument panel and heater control lighting

Because of the location of the above lamps, a Volvo workshop should be given the job of replacing them.

Replacing the side marker light bulbs

Remove the two cross head screws holding the glass. Take out the bulb by pressing it in slightly while turning it anticlockwise at the same time.

POWER TRANSMISSION

32 Check the release arm free travel

To avoid risk of the clutch slipping, the release arm free travel should be checked and adjusted if necessary every 10,000 km (6000 miles). For data see page 59.

The clutch should be checked and adjusted at a workshop which has the proper equipment.

33 Check the propeller shaft

After every 10,000 km (6000 miles) or once a year the rubber seal on the spline shaft and the universal joints should be checked. If the rubber seal is damaged, it should be replaced and the new seal filled with molybdenum disulphide grease.

BRAKES

34 Check the brakes

After every 10,000 km (6000 miles) the vehicle should be taken to a Volvo workshop for a check on the functioning of the brakes.

35 Replacing the booster cylinder air filter and overhaul of brakes

Every 60,000 km (36,000 miles) the car should be taken to a Volvo workshop for replacement of the booster cylinder air and damper filters.

Replacement should be more frequent when driving often on dusty roads. The brake system seals should also be replaced every 3rd year or 60,000 km (36,000 miles).

FRONT END

36 Check the front wheel alignment

Correct front wheel alignment is of vital importance for the steering of the vehicle. Faulty adjustment can mean heavy wear on the tyres. For this reason, have the front wheel alignment checked regularly at your local Volvo workshop every 10,000 km (6000 miles). If the vehicle has been in a collision involving heavy impact and it is suspected that the front end may have been affected, take the vehicle to a Volvo workshop for a check on the front wheel alignment as soon as possible. Volvo workshops have special measuring equipment for this purpose and can carry out this control quickly and efficiently. The front wheel alignment angles are given on page 59.

37 Check the ball joints, steering rods, etc. After every 10,000 km (6000 miles) the vehicle should be taken to a workshop for a check on the front end concerning excessive play in the ball joints, steering gear, etc.

After every 10,000 km (6000 miles) or at least once a year, the ball joint seal should also be checked for damage and leakage. When new seals are fitted they should be filled with the recommended grease.

SERVICING

WHEELS AND TYRES

General

The car is fitted with pressed steel wheels with wheel cap which is bolted to the hub cap.

The wheels have size 5¹/₂ J 15" F. H. All wheels are accurately balanced. The tyres are radial type tubeless with size 165 SR 15 (on certain markets 165 HR 15).

With the 165 SR 15 tyre, the maximum permissible speed is 185 km.p.h. (115 m.p.h.).

Many tyre makes have a so-called "wear indicator" in the form of a number of narrow strips running across or parallel to the tread. When about 1.5 mm (¹/₁₆") is left on the tread, these strips show up and warn the car owner in good time that the tyre is showing signs of wear.

Recommended for use in winter are radial type tyres with size 165 SR 15 (165 SR 380) with or without studs.

Chains must not be fitted on the Volvo 164 wheels since the space between the brake calipers and wheel rims does not permit this.

If possible, the wheels should always be used on the same side throughout their lifetime. This is particularly important for studded winter tyres, otherwise it can

happen that the studs loosen and fall out if the tyre is placed on the other side.

Check the tyres at regular intervals for damage and abnormal wear, also for particles which can fasten in the tread. Have them balanced if necessary. Poorly balanced wheels will rapidly increase the wear on tyres as well as make for poor travelling comfort.

38 Check the tyre pressure

Make a habit of checking the pressure in the tyres regularly. The simplest way to do this is to check the pressure at a service station while filling up with fuel. See page 59 for the correct air pressure. Do not forget the spare wheel when checking the air pressure.

During driving, the temperature of the tyres rises and also the air pressure in relation to the speed of the vehicle and its load. Normally the air pressure should only be checked when the tyres are cold. When the tyres are warm, a change in pressure should take place only when air must be pumped into the tyres.

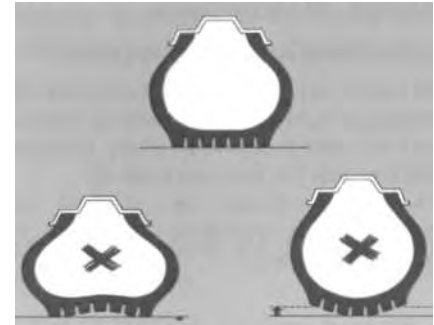

Excessively low air pressure is one of the most common reasons for tyre wear. If the pressure is too low, the tread shoulders bear the entire load and wear down very quickly. Tyres which are insufficiently inflated also result in difficult steering and high fuel consumption. Too high air pressure means tyre wear along the centre of the tread. It also tends to make travelling less comfortable.

Be careful when parking the car next to the pavement not to damage the tyres against the pavement kerb.

Changing the wheels

Before jacking up the car, apply the parking brake and engage a gear.

Removing

Unscrew the crossheaded bolt (Fig. 1) for the wheel cap and take off the cap. Slacken the wheel nuts $\frac{1}{2}$ -1 turn with the box spanner and lever. All nuts are right-hand threaded, that is, they are slackened by being unscrewed anti-clockwise, see Fig. 2.

Fit the jack in the eyelet near to the wheel to be lifted, see Fig. 3. Jack up the car so high that the wheel comes off the ground.

Remove the wheel nuts and lift off the wheel. Observe due care that the threads on the wheel studs are not damaged. Remove the hub cap.

Fitting

Clean the contact surfaces between wheel and hub. Fit the hub cap on the wheel, see Fig. 4. Fit the wheel.

Tighten the wheel nuts so that the wheel is firmly against the hub.

Lower the car and tighten the wheel nuts finally, taking every other nut at a time. Screw on the wheel cap.



SERVICING

BODY

39 Washing

The car should be washed often to prevent dust, dirt, dead insects, tar spots, etc., from damaging the paintwork.

The washing should be regular and thorough particularly during the wintertime, since it is difficult to wash off the mixture of road salt, asphalt, dust and dirt if allowed to remain on the paintwork for some time. Such a mixture also stimulates rusting both on the paintwork and the underbody of the car.

When about to wash the car, place it out of strong sunlight and start by softening the dirt with a fine jet of water.

Apply a strong jet and wash thoroughly the entire underbody.

Wash the body with a sponge or brush and apply plenty of water.

Start at the roof and proceed downwards. Use preferably tepid water, but not hot water. Make sure that nothing fastens in the sponge or brush which can damage the paintwork.

Car wash or ordinary fluid dish washing agent can be used to facilitate the washing. A suitable dosage of fluid dish washing agent is 5-10 cl (1.5-3.5 fl. ozs.) to 10 litres (2.2 Imp. galls. = 2.6 US galls.)

water. Asphalt spots and tar splash can be removed with white spirit or similar. This should be done after the washing.

When a washing agent is used, the car should be well rinsed down with clean water afterwards. Begin with the roof of the car and work down the body. Then dry carefully with a soft clean chamois leather. Use different leathers for the windows and the remainder of the car, since using the same leather can cause greasy smears on the windows. When washing the car, remember to clean the drainage holes in the doors and bottom rail.

If the car is washed in any automatic high-pressure washing unit, the defroster control and the two fresh-air intakes to the front seat floor must be closed. Otherwise there is risk of water coming into the car owing to the high pressure of the water.

40 Polishing and waxing

The vehicle does not need polishing until the surface finish begins to lose its lustre and normal washing is no longer sufficient to make it shine again and remove the layer of dirt on the surface. Under normal conditions it is sufficient to polish the vehicle a couple of times a year on condition that it is carefully looked after and thoroughly washed as soon as it has become dirty or dusty.

Before the vehicle is polished, it should be carefully washed and dried to avoid scratches on the paintwork.

When about to apply wax, make sure that the surface is absolutely clean before application. It is often necessary to use cleaning naphtha for cleaning.

Waxing is no substitute for polishing. Nor is it necessary as a protection for the paintwork against unfavourable weather. Very often waxing should first be carried out at the earliest one year after delivery of the car.

Touching-up surface finish damage

The touching-up of any extensive damage to the synthetic finish requires the use of special equipment and skill, so that the repairing of any such damage should be entrusted to a Volvo workshop. Minor damage caused by flying gravel, etc. and small scratches can, however, be attended to by the owner himself.

Damage caused by flying stones requires immediate treatment if damage from rust is to be avoided. Always make a habit, therefore, of checking the finish regularly and carrying out touching-up if required. Volvo dealers can supply you with suitable touching-up paint in tins or spray bottles. Always make sure that you get exactly the right colour. Touching-up is as follows:

1. If flying gravel should penetrate down to the metal, the damaged surface should be scraped completely clean with a pen-knife or similar.
If the paintwork has not been damaged by flying gravel, a light scraping will remove the dirt.
2. In the event of severe damage due to flying stones, it is necessary to treat the spot concerned with anti-rust primer. The primer should cover completely the scratched and rubbed down edges.
3. When the anti-rust primer has dried, genuine Volvo paint is applied. Stir the paint well or shake the spray bottle thoroughly before use. Apply several thin coats of the paint allowing it to dry thoroughly between each application.

Chromed parts

The chromium-plated and anodized parts should be washed with clean water as soon as they become dirty. This is particularly important if you drive on gravel roads which are treated with chemicals to keep the dust down or in the winter when salt is used to melt the snow. After the car has been washed, wax or anti-rust preparation can be applied.

41 Anti-rust treatment

The Volvo 164 is anti-rust treated at the factory. Underbody sealing compound is applied to the underbody on those places exposed to damage from flying stones thrown up by the wheels, i.e. the wheel arches, the entire floor plate and the underside of the sills. Anti-rust fluid is sprayed on the chassis parts. Inspection and any touching-up of the anti-rust protection should be done at regular intervals and at least once a year. The enclosed body sections should also be anti-rust treated by means of spray application at least once a year.

If any touching-up of the anti-rust protection is necessary, this should be done immediately to prevent moisture from seeping in and causing damage.

42 Cleaning the upholstery

The Volvo 164 is available with two different upholstery combinations: leather and vinyl or fabric and vinyl.

A damp cloth, possibly moistened with a mild soap solution, should be used for cleaning the leather upholstery. For the removal of more difficult spots, an expert should be consulted concerning the choice of cleaning agent.

Normally many different kinds of spots can be removed from fabric with soap and water or washing agent.

For more difficult spots, e.g., from asphalt, oil, ice-cream, shoe cream, butter, etc., carbon tetrachloride - petrol (equal parts carbon tetrachloride and chemically pure petrol) can be used on the fabric upholstery.

The vinyl is washed with mild soap solution or, in more difficult cases, with a household washing agent.

Petrol, white spirit, carbon tetrachloride or similar cleaning agents must not be used for the leather upholstery and vinyl since these agents damage the leather upholstery and vinyl.

Cleaning the floor mats

The floor carpets should be vacuum-cleaned or brushed clean regularly. Now and again, and specially during the wintertime, they should be taken out for drying. Mild washing agent will remove any spots.

SERVICING

BEFORE A LONG-DISTANCE TRIP

If you are thinking of taking your car abroad or on a long journey, have it checked at a Volvo workshop. You will enjoy your journey better if you know that your car is in perfect trim. Irritating incidents can be avoided as well as expensive and time-absorbing stoppages. Wherever you go there should be a Volvo workshop within easy reach to attend to your car if required.

However, it is always a good idea before making a trip to ensure that, at least on a minor scale, you have with you a comprehensive touring kit. This is particularly the case if you anticipate widely varying conditions as regards climate, roads and the prevalence of much dust. Many workshops stock special kits for this purpose. Remember when filling up with fuel to observe the existing fuel recommendations. If you prefer to look over your vehicle yourself, the following hints are worthwhile noting:

1. Check the brakes, front wheel alignment and steering gear.
2. Check the engine and drive units with regard to fuel, oil, coolant leakage.
3. Examine the tyres carefully. Replace worn tyres.

4. Check that the engine is running perfectly and that fuel consumption is normal.
5. Examine the state of charge of the battery and clean the terminals.
6. Look over the tool equipment and check the spare wheel.
7. Check that the lighting functions properly.

PROCEDURE IN COLD WEATHER

When cold weather is on the way, it is time to think of the winter servicing of your car. The first night of frost can come as a very unpleasant surprise unless preventive precautions have been taken.

Engine cooling system

A good quality anti-freeze should be used all the year round. Thus, the cooling system should always contain a mixture of 50 % anti-freeze and 50 % water. Concerning changing coolant, see page 43. Experience has also shown that extremely weak anti-freeze solutions (10-25 %) are very unfavourable from the point of view of rust protection. For this reason, the quantity of anti-freeze should amount to about 50 % of the coolant, that is, 6.2 litres (11 Imp. pints = 13 U.S. pints), this lowering the freezing point to -35°C (31°F). Radiator spirit is not recommended as an anti-freeze agent since it evaporates at normal engine temperature.

Engine lubricating system

During the winter multigrade oil or engine oil SAE 10 W should be used for the engine lubricating system. At very low temperatures (below $-20^{\circ}\text{C} = -4^{\circ}\text{F}$) multigrade oil SAE 5 W-20 is recommended. This oil reaches the lubricating points in the engine more easily at low temperature and also facilitate cold starting. See page 37.

Electrical system

The electrical system in the vehicle is subjected to greater stresses during the winter than during the warm summer months. The lighting and starter motor are used more and since the capacity of the battery is also considerably lower at low air temperature, the state of charge must be checked more often and, if necessary, the battery charged. If the battery voltage is excessively low, there is risk of the battery being damaged by frost.

Brake system

During very cold weather the brakes are subjected to splash and condensation water which can result in the handbrake freezing up if left on.

When you park the car, do not apply the handbrake but engage the first gear or reverse and if possible place blocks behind the wheels. See also page 23.

Windscreen washer

In the same way as anti-freeze is added to the cooling system during the winter to prevent frost damage, anti-freeze should also be added to the water container for the windscreen washers. This is particularly important because the windscreen during the winter frequently becomes dirty and is often splashed with water which rapidly freezes and thus necessitates the frequent use of the windscreen washer and wipers. Your Volvo dealer can supply you with suitable anti-freeze for this purpose.

Anti-freeze for door locks

A frozen door lock is one of the most irritating things that can happen to a car-owner. Remember this in good time and lubricate the locks in advance with some suitable anti-freeze agent. Such agents are now available in small handy tubes which can easily be placed in a handbag or coat pocket.

Engine fuel system

During the wintertime with large variation in temperature, condensation water forms in the fuel tank and this can impair the running of the engine. This can be eliminated by adding carburettor spirit to the fuel. Also, there is less risk of condensation water forming if the tank is kept well-filled.

FAULT TRACING

WHEN THE ENGINE STALLS OR WILL NOT START

The information given below is only intended to serve as a guide in localizing and temporarily correcting minor faults. After having carried out any such measures, have them checked and adjusted by an experienced mechanic.

The engine does not start although the starter motor turns it over at normal speed

1. Check that there is fuel in the tank.
2. If the engine is warm, starting should be done with the accelerator pedal slowly depressed as far as it will go.
3. In wet weather the spark plug insulators should be wiped clean and the distributor cap removed and wiped dry if flash-over is suspected.
4. Check that the fuel line connections on the pump and carburettor are not leaking and that fuel is supplied to the carburettors.
5. If the engine is turned over for a while without having started, too rich a fuel mixture can enter the cylinders so that the spark plugs become wet. Blow the cylinders clean by screwing out the spark plug and turning over the engine with the starter motor. Dry the spark plugs before fitting them.

If the engine still does not start

1. Remove the ignition lead from each plug in turn. Hold the end of the lead about "14" from the cylinder block while turning over the engine with the ignition switched on. If there is a strong spark, the fault is probably in the spark plugs, so these should be changed.
2. If only a weak spark is obtained or none at all, check to see whether the ignition leads are properly inserted in the distributor and ignition coil.
3. Remove the distributor cap, check and clean all contact surfaces. Check that the contact breakers close properly when the engine is turned over. If the contact breaker arm shaft binds, oil it very sparingly.

If the engine misfires, the reason can be:

1. That one of the ignition leads has loosened in the distributor cover or from the sparking plug.
2. That one or more of the spark plugs is coated with soot or oiled up, in which case the plug concerned should be cleaned or changed and the spark plug gap adjusted.

3. That the distributor cap and rotor arm are cracked or damaged.
4. That one of the ignition leads is in a poor condition.
5. That the contact breaker gap in the distributor is insufficient or non-existent.
6. That the contact breakers are badly burnt.

How to start your car downhill

Switch on the ignition, pull out the choke if required, engage 3rd gear or even 4th and let the car roll downwards with the clutch pedal depressed. When the speed is up to 15-20 km.p.h. (9-12 m.p.h.), and not before, release the clutch pedal slowly. Being towed: Secure the towline to the towing loop. The car is towed at an even speed in 2nd gear. Try starting as suggested in the previous paragraph.

MEASUREMENTS AND WEIGHTS

Length	4705 mm (185")
Width	1735 mm (68.3")
Height unladen (ready to drive)	1437 mm (56.5")
Wheelbase	2720 mm (107")
Ground clearance, fully laden	125 mm (4.9")
Track, front	1350 mm (53.2")
rear	1350 mm (53.2")
Turning circle	9.6 m (31.6 ft.)
Kerb weight	1350–1380 kg (2975–3040 lb.)
	depending on chassis type
Permissible total weight	1825 kg (4015 lb.)
Permissible load (excluding driver)	375–405 kg (825–892 lb.)
	depending on chassis type
Permissible axle pressure, front	900 kg (1980 lb.)
rear	1000 kg (2200 lb.)
Permissible roof rack load	100 kg (220 lb.)
Max. permissible trailer weight	1200 kg (2640 lb.)

ENGINE

Type designation	B 30
Output (DIN) at r.p.m.	130 h.p./5000
Output (SAE) at r.p.m.	145 h.p./5500
Max. torque (DIN) at r.p.m.	21 kpm (152 lb.ft.)/2500
Max. torque (SAE) at r.p.m.	22.5 kpm (163 lb.ft.)/3000
Number of cylinders	6
Bore	88.90 mm (3.50")
Stroke	80 mm (3.15")
Displacement	2.98 litres
Compression ratio	9.3:1
Valves	Overhead
Valve clearance, warm and cold,	0.50–0.55 mm
inlet	(0.020–0.022")
exhaust	0.50–0.55 mm (0.020–0.022")
Idling speed (warm engine)	800 r.p.m. (700 r.p.m. with BW 35)

Fuel system

Carburettor, type	Horizontal
designation	Zenith-Stromberg 175 CD 2 SE

Cooling system

Type	Closed system positive pressure approx. 0.7 kp/cm ² (10 p.s.i.)
Thermostat, begins to open at	82° (180°F)
fully open at	90°C (194°F)

SPECIFICATIONS

Ignition system

Firing order	1-5-3-6-2-4
Ignition setting	
stroboscope setting at 600-800 r.p.m.	
with both vacuum hoses disconnected	10° B.T.D.C.
Spark plugs, normal driving	Bosch W 200 T35*
mostly town driving	Bosch W 175 T35*
spark plug gap	0.7-0.8 mm (0.028-0.032")
tightening torque	3.5-4.0 kgm (25-29 lb.ft.)
Distributor, direction of rotation	Anti-clockwise
contact breaker gap	0.25 mm (0.010")

Electrical system

Voltage	12 V
Battery, type	Tudor 6 EX4 F o.p.*
capacity	60 Ah
electrolyte, specific gravity recharged at	1.28
recharged at	1.21
Alternator max. output	770 W
max. current	55 A
Starter motor, output	1 h.p.

* or corresponding

Lamp bulbs (12 V)

	Power	Socket	Number
Headlights	45/40 W	P 45 T	2
Foglights	55 W	P 14.5 S	2
Parking lights, front	5 W	Ba 15 s	2
Flashers, front and rear	32 cp	Ba 15 s	4
Side marker lights	4 cp	Ba 15 s	4
Stop lights	32 cp	Ba 15 s	2
Reversing lights	32 cp	Ba 15 s	2
Rear lights	5 W	Ba 15 s	2
License plate light	5 W	SV 8.5	2
Interior lighting	10 W	SV 8.5	1
Glove compartment light	2 W	Ba 9 s	1
Engine and luggage compartment lights	18 W	SV 8.5	2
Instrument lighting	3 W	W 2.2 d	2
Lighting, heater controls	1.2 W	W 1.8 d	3
Clock light	2 W	Ba 7 s	1
Warning lamps:			
charging	1.2 W	W 1.8 d	1
turn indicators	1.2 W	W 1.8 d	1
brakes	1.2 W	W 1.8 d	1
headlights	1.2 W	W 1.8 d	1
oil pressure	1.2 W	W 1.8 d	1
elec. heated rear window	1.2 W	W 1.8 d	1
overdrive	1.2 W	W 1.8 d	1
emergency warning flashers	1.2 W	W 1.8 d	1

Fuses (in ordinary fusebox)

4	5 A
4	8 A
1	16 A

Fuses (in fusebox, engine compartment)

2	8 A
---	-----

POWER TRANSMISSION

Clutch

Release lever free travel 4–5 mm (approx. $\frac{3}{16}$ "
 right-hand drive 2–3 mm ($\frac{3}{32}$ "

Gearbox

Type designation	M 400	M 410	BW 35	
Reduction ratios:				} × the con- verter ratio
1st speed	3.14:1	3.14:1	2.39:1	
2nd speed	1.97:1	1.97:1	1.45:1	
3rd speed	1.34:1	1.34:1	1:1	
4th speed	1:1	1:1	—	
(with overdrive)	—	0.797:1	—	
Reverse	3.54:1	3.54:1	2.09:1	

Rear axle

Type Hypoid bevel gear
 Reduction ratio 3.73:1 3.31:1 (for BW 35)

FRONT WHEEL ALIGNMENT

The alignment values apply to an unladen car but include fuel, coolant and spare wheel.

Toe-in 0–4 mm (0.16")
 Camber 0 to $+\frac{1}{2}$ °
 Caster 0 to $+1$ °
 King pin inclination 7.5°

WHEELS AND TYRES

Rim size	5½ J 15 F.H.	
Tyre size	165 R SR 15*	
Air pressure cold tyres, kp/cm ² (p.s.i.)	Front	Rear
1–3 persons	1.9 (27)	1.9 (27)
Fully loaded	2.0 (28)	2.4 (34)

* On certain markets 165 HR 15.

For long-distance driving at high speed, the pressure must be increased by 0.3 kp/cm² (4.3 p.s.i.). However, total pressure must not exceed 2.5 kp/cm² (36 p.s.i.).

CAPACITIES

Fuel tank 58 litres (12.76 Imp. galls = 15.31 US galls)
 Cooling system 12.4 litres (2.73 Imp. galls = 3.27 US galls)
 (of which expansion tank 1.5 litres = 3.2 Imp. pints = 2.6 US pints)

Oil capacities:
 engine, at oil change 5.2 litres (9.0 Imp. pints = 11.0 US pints)
 incl. oil filter 6.0 litres (10.6 Imp. pints = 12.6 US pints)
 gearbox (M 400) 0.6 litre (1.1 Imp. pints = 1.3 US pints)
 (M 410) 1.4 litres (2.5 Imp. pints = 3.0 US pints)
 (automatic) 8.2 litres (14.4 Imp. pints = 17.3 US pints)
 rear axle 1.6 litres (2.8 Imp. pints = 3.4 US pints)
 steering gear 0.6 litre (1.1 Imp. pints = 1.3 US pints)
 servo steering 1.2 litres (2.0 Imp. pints = 2.5 US pints)

TOOL KIT

Wheel nut box spanner	Adjustable spanner
Tommy bar	Philips screwdriver
Pliers	Plain screwdriver

LUBRICATING CHART

Symbols



Brake fluid

Grade: SAE 70 R3, SAE 70 R3 (J 70 B) or SAE J 1703



Rear axle oil

Grade: MIL-L-2105 B
Viscosity: See page 39



Special lubricants

See resp. note



Light engine oil



Engine oil

Grade: For Service MS
Multigrade
See also page 37

Check the following when filling the tank

1. Check the engine oil level.
2. Check without removing the cap that the level in the brake fluid container is above the MIN mark. (Right-hand steering: Check also the clutch fluid level.)
3. Check that the coolant level is between the MAX and MIN marks on the expansion tank.
4. Check that the fluid container for the windscreen washer is filled.

About every other week check:

1. The tyre pressure.
2. The battery acid level.

Notes for lubricating chart

Note 1. The front wheel bearings are packed at the factory with a special type of grease intended to last for the entire lifetime of the bearings. Normally, therefore, the sealed-for-life bearings do not require a change of lubricant or additional grease. In connection with such workshop operations involving uncovering the wheel bearings, the bearings should be cleaned and then lubricated with high-class, durable grease according to the instructions in the service manual. Except on the above occasion, subsequent adding or changing of lubricant is not required.

The rear wheel bearings are lubricated so replacement of grease is not required. However, if the bearings have been removed, they should be lightly greased with wheel bearing grease.

Note 2. Mechanical steering:

Check that the oil reaches up to the filler plug. Use hypoid oil SAE 80 all year round. Servo steering: Check that the oil level in

the servo steering container is 5–10 mm ($\frac{5}{16}$ ") above the level mark. Use Automatic Transmission Fluid, Type A, or Dexron.

Note 3. Check that the fluid reaches up to the MAX mark. (Right-hand steering: Check also the clutch fluid level.)

Note 4. Lubricate the felt wick under the rotor and fill a few drops of light engine oil into the lubricating cup.

Note 5. Check every 10,000 km (6000 miles) that the oil reaches up to the filler plug. Concerning oil change, see page 38.

N.B. The type of gearbox will decide the type of lubricant to be used.

Note 6. At every engine oil change check that the oil level in the centre spindle of the carburettors reaches up to about 6 mm ($\frac{1}{4}$ ") from the edge of the spindle. Use oil ATF type F (transmission oil).

Note 7. Change the oil filter every 10,000 km (6000 miles). See page 41.

Note 8. Check the oil level when tanking. Concerning oil changing, see page 37.

Note 9. Check every 10,000 km (6000 miles) that the oil reaches up to the filler plug. Concerning lubricant for rear axle with differential lock, see page 39.

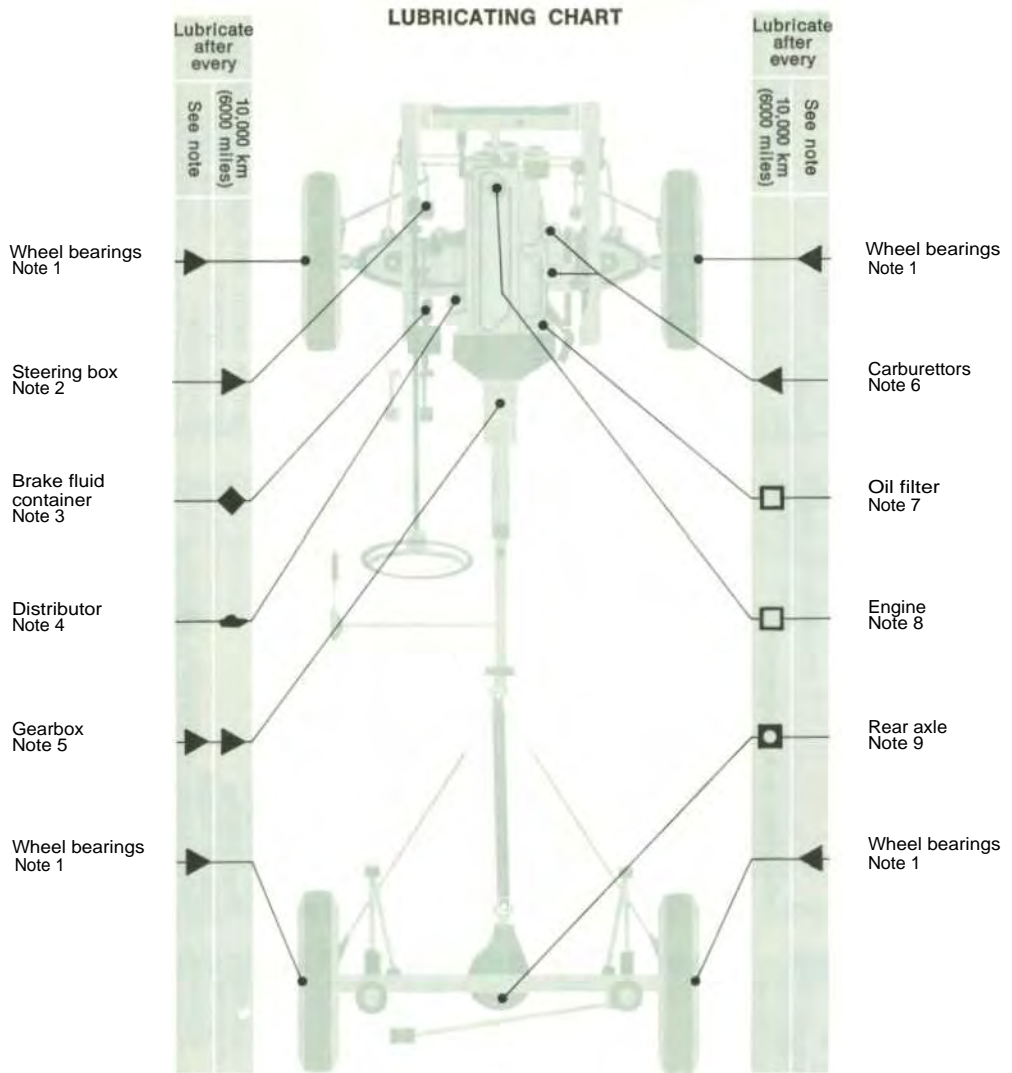

Oil capacities

Engine excl. oil filter
incl. oil filter approx.

Gearbox, M 400
M 410
BW 35

Rear axle

Steering gear (mech.)

Servo steering

approx. 5.2 litres (9.0 Imp. pints = 11.0 US pints)

approx. 6.0 litres (10.6 Imp. pints = 12.6 US pints)

approx. 0.6 litre (1.1 Imp. pints = 1.3 US pints)

approx. 1.4 litres (2.5 Imp. pints = 3.0 US pints)

approx. 8.2 litres (14.4 Imp. pints = 17.3 US pints)

approx. 1.6 litres (2.8 Imp. pints = 3.4 US pints)

approx. 0.6 litre (1.1 Imp. pints = 1.3 US pints)

approx. 1.2 litres (2.0 Imp. pints = 2.5 US pints)

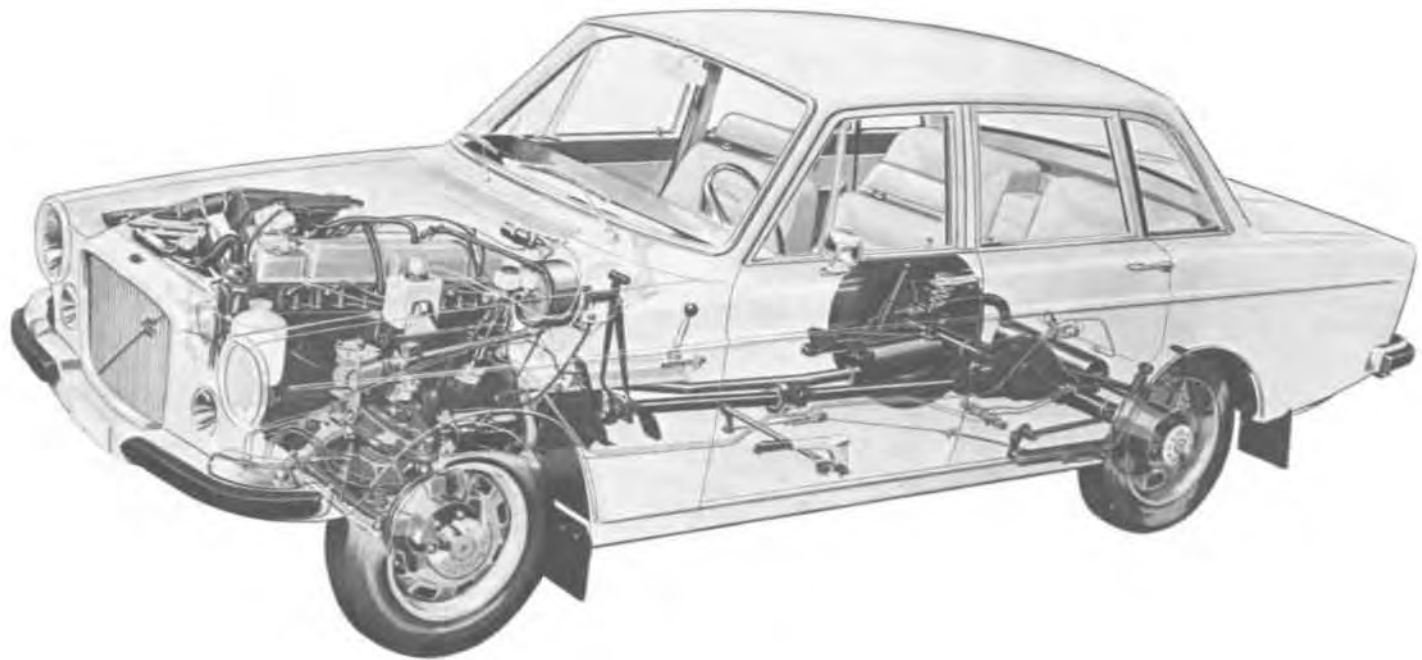

CHECKS WHEN FILLING THE TANK

The only servicing required between the 10,000 km (6000 miles) inspections are the checks listed opposite, which should be carried out when filling the tank.

- **Fuel**
Make sure that the octane rating for the fuel is at least 100. If you drive only on highways, 97 octane can be used.
- **Oil level in engine**
The oil should be between the marks on the dipstick. If necessary, top up with multigrade oil, see page 37.
- **Coolant level**
The coolant should be between the Max. and Min. marks on the expansion tank. When filling up, use a mixture of 50 % anti-freeze and 50 % water.
- **Brake fluid level**
Check without removing the cap that the level is above the Min. mark. If necessary, fill with brake fluid SAE 70 R 3.
- **Windscreen washer level**
The windscreen washer container should always be well-filled, with water and anti-freeze during the wintertime.

When filling the tank every other time, the following should also be checked:

- **Acid level in battery**
The level should be up to the lower edge on the slit tubes in the cover.
- **Pressure in tyres**

	front	rear
1–3 persons	1.9 kp/cm ² (27 p.s.i.)	1.9 kp/cm ² (27 p.s.i.)
Fully loaded	2.0 kp/cm ² (28 p.s.i.)	2.4 kp/cm ² (34 p.s.i.)

For long-distance driving at high speed, the pressure should be increased by 0.3 kp/cm² (4.3 p.s.i.). The total pressure, however, must not exceed 2.5 kp/cm² (36 p.s.i.).

AKTIEBOLAGET VOLVO GÖTEBORG SWEDEN
